

# STRONG

## Terrestrial HDMI Receiver for your TV SRT 82



Picture similar

User Manual  
Bedienungsanleitung  
Manuel d'utilisation  
Manuale d'uso  
Manuale utente  
Manual del usuario  
Instrucciones de instalación  
Návod k obsluze

Používateľská príručka  
Telepítési Utasítás  
Bruksanvisning  
Uživatelská příručka  
Korisnički priručnik  
Používateľská príručka  
Руководство пользователя  
Εγχειρίδιο χρήστη



USB  
recording



Timeshift



Programme  
guide



Favourite  
lists

DVB-T2

HDMI™

HE Advance™

Dolby Audio

[www.strong.tv](http://www.strong.tv)

Fig. 1



Fig. 2

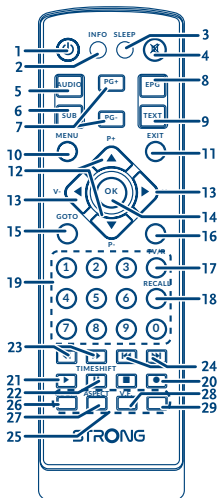

Fig. 3

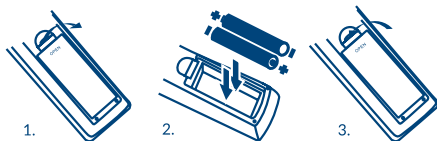

Fig. 4

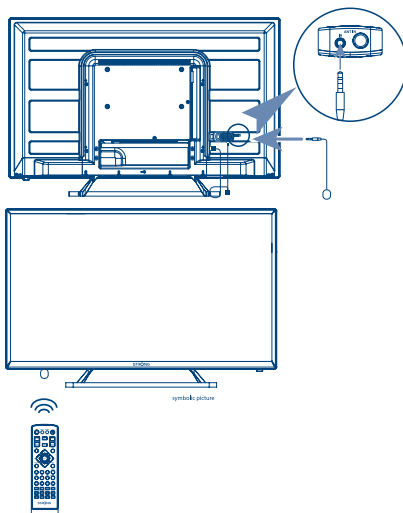

Fig. 5

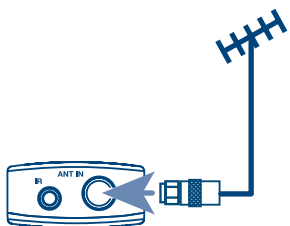
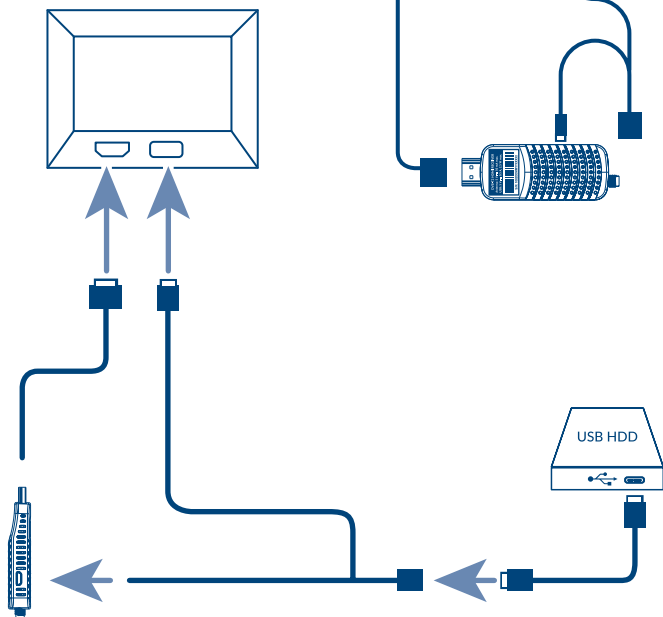

Fig. 6



## HOTLINE

<b>AT</b>	<b>0820 400 150</b> support_at@strong.tv € 0,12/Min. österr. Festnetz	<b>FR</b>	<b>0826 029 928</b> support_fr@strong.tv € 0,15 par mn poste fixe en France
<b>BG</b>	<b>+359 32 634451</b> support_bg@strong.tv	<b>IT</b>	<b>199 404 032</b> support_it@strong.tv Da rete fissa 24,8 cent. al min. 12,5 cent. scatto alla risposta Da rete mobile max 49 cent. al min. 15,6 cent. scatto alla risposta
<b>CEE</b>	<b>+36 1 445 26 10</b> support_hu@strong.tv	<b>NL</b>	support_nl@strong.tv
<b>DE</b>	<b>0180 501 49 91</b> support_de@strong.tv € 0,14/Min. deutsches Festnetz € 0,42/Min. max. Mobilfunknetze	<b>PL</b>	<b>801 702 017</b> support_pl@strong.tv
<b>DK</b>	support_dk@strong.tv	<b>UA</b>	<b>+380(44)238 61 50</b> support_ua@strong.tv

Supplied by STRONG Austria  
Represented by  
STRONG Ges.m.b.H.  
Teinfaltstraße 8/4.Stock  
1010 Vienna  
Austria  
Email: support\_at@strong.tv

18 Jan 2022 18:15

## Licenses

THIS PRODUCT IS LICENSED UNDER THE AVC PATENT PORTFOLIO LICENSE FOR THE PERSONAL AND NONCOMMERCIAL USE OF A CONSUMER TO (i) ENCODE VIDEO IN COMPLIANCE WITH THE AVC STANDARD ("AVC VIDEO") AND/OR (ii) DECODE AVC VIDEO THAT WAS ENCODED BY A CONSUMER ENGAGED IN A PERSONAL AND NON-COMMERCIAL ACTIVITY AND/OR WAS OBTAINED FROM A VIDEO PROVIDER LICENSED TO PROVIDE AVC VIDEO. NO LICENSE IS GRANTED OR SHALL BE IMPLIED FOR ANY OTHER USE. ADDITIONAL INFORMATION MAY BE OBTAINED FROM MPEG LA, L.L.C. SEE [HTTP://WWW.MPEGLA.COM](http://www.mpegla.com)

This product contains one or more programs protected under international and U.S. copyright laws as unpublished works. They are confidential and proprietary to **Dolby Laboratories**. Their reproduction or disclosure, in whole or in part, or the production of derivative works therefrom without the express permission of Dolby Laboratories is prohibited. Copyright 2003-2009 by Dolby Laboratories. All rights reserved.

THIS PRODUCT IS SOLD WITH A LIMITED LICENSE AND IS AUTHORIZED TO BE USED ONLY IN CONNECTION WITH HEVC CONTENT THAT MEETS EACH OF THE THREE FOLLOWING QUALIFICATIONS: (1) HEVC CONTENT ONLY FOR PERSONAL USE; (2) HEVC CONTENT THAT IS NOT OFFERED FOR SALE; AND (3) HEVC CONTENT THAT IS CREATED BY THE OWNER OF THE PRODUCT. THIS PRODUCT MAY NOT BE USED IN CONNECTION WITH HEVC ENCODED CONTENT CREATED BY A THIRD PARTY, WHICH THE USER HAS ORDERED OR PURCHASED FROM A THIRD PARTY, UNLESS THE USER IS SEPARATELY GRANTED RIGHTS TO USE THE PRODUCT WITH SUCH CONTENT BY A LICENSED SELLER OF THE CONTENT. YOUR USE OF THIS PRODUCT IN CONNECTION WITH HEVC ENCODED CONTENT IS DEEMED ACCEPTANCE OF THE LIMITED AUTHORITY TO USE AS NOTED ABOVE.

## TABLE OF CONTENTS

<b>1.0 INTRODUCTION</b>	<b>3</b>	6.1 Changing channels	9
1.1 Safety Instructions	3	6.2 Info Banner	9
1.2 Storage	4	6.3 Selection of audio language	9
1.3 Equipment Set-up	4	6.4 Teletext	9
1.4 Accessories	4	6.5 Subtitles	10
1.5 Usage of external USB devices	5	6.6 Timeshift	10
<b>2.0 YOUR RECEIVER</b>	<b>5</b>	6.7 EPG (Electronic Programme Guide)	10
2.1 PIN-CODE DEFAULT: 1234	5	6.8 Instant Recording	10
2.2 Side Panel	5	6.9 Sleep	10
2.3 Remote Control	6	<b>7.0 MAIN MENU</b>	<b>11</b>
2.4 Installing the batteries	6	7.1 Programme	11
2.5 Using the remote control and the IR extender.	7	7.2 EPG (Electronic Programme Guide)	12
<b>3.0 CONNECTION</b>	<b>7</b>	7.3 LCN (Logical Channel Numbering)	12
3.1 Connecting to a terrestrial antenna	7	7.4 Picture	13
3.2 Connecting to TV with HDMI extender cable or directly to HDMI port.	7	7.5 Channel Search	13
3.3 Connecting a USB storage device	7	7.6 Time	14
<b>4.0 STARTING UP FOR THE FIRST TIME</b>	<b>8</b>	7.7 Option	14
<b>5.0 QUICK GUIDE TO USING YOUR RECEIVER</b>	<b>8</b>	7.8 System	14
		7.9 USB	15
<b>6.0 OPERATION</b>	<b>8</b>	<b>8.0 TROUBLESHOOTING</b>	<b>16</b>
		<b>9.0 TECHNICAL SPECIFICATIONS</b>	<b>20</b>

### SIMPLIFIED EU DECLARATION OF CONFORMITY

Hereby, STRONG declares that the device SRT 82 is in compliance with Directive 2014/53/EU.



The full text of the EU declaration of conformity is available at the following internet address: <https://www.strong.tv/en/doc>

Subject to alterations. In consequence of continuous research and development technical specifications, design and appearance of products may change. The terms HDMI and HDMI High-Definition Multimedia Interface, and the HDMI logo are trademarks or registered trademarks of HDMI Licensing Administrator, Inc in the United States and other countries. Manufactured under license from Dolby Laboratories. Dolby Audio and the double-D symbol are registered trademarks of Dolby Laboratories. All product names are trademarks or registered trademarks of their respective owners.

© STRONG 2022. All rights reserved.

## 1.0 INTRODUCTION

### 1.1 Safety Instructions

- Read all of the instructions before operating the device. Keep these instructions well for later use.
- Only use attachments/accessories specified or provided by the manufacturer (such as the exclusive supply adapter, battery etc.).
- Please refer to the information on the product enclosure for electrical and safety information before installing or operating the apparatus.
- To reduce the risk of fire or electric shock, do not expose this apparatus to rain or moisture.
- The ventilation should not be impeded by covering the ventilation openings with items, such as newspaper, table-cloths, curtains, etc.
- The apparatus shall not be exposed to dripping or splashing and no objects filled with liquids, such as vases, shall be placed on the apparatus.
-  This mark indicates a risk of electric shock.
- To prevent injury, this apparatus must be securely attached to the floor/wall in accordance with the installation instructions.
- Danger of explosion if the battery is incorrectly replaced. Replace only with the same or equivalent types.
- The battery (battery or batteries or battery pack) shall not be exposed to excessive heat such as sunshine, fire or the like.
- Excessive sound pressure from earphones and headphones can cause hearing loss.
- Listening to music at high volume levels and for extended durations can damage one's hearing.
- In order to reduce the risk of damage to hearing, one should lower the volume to a safe, comfortable level, and reduce the amount of time listening at high levels.
- The mains plug or appliance coupler is used as disconnect device, it shall remain readily operable. When not in use and during movement, please take care of the power cord set, e.g. tie up the power cord set with cable tie or something like that. It shall be free from sharp edges or similar which can cause abrasion of the power cord set. When put into use again, please make sure the power cord is not damaged. The absence of a light indication on the apparatus does not mean that it is fully disconnected from the mains. To disconnect the apparatus completely, the mains plug must be pulled out.
- Attention should be drawn to environmental aspects of battery disposal.
- No naked flame sources, such as lighted candles, should be placed on the apparatus.
-  To prevent the spread of fire, keep candles or other open flames away from this product at all times.
-  Equipment with this symbol is a Class II or double insulated electrical appliance. It has been designed in such a way that it does not require a safety connection to electrical earth.

#### Precautions

Never try to open the device. It is dangerous to touch the inside of the device due to high voltages and possible electrical hazards. Opening the device will void the warranty of the product. Refer all maintenance or servicing to suitably qualified personnel.

When you are connecting cables, be sure that the device is disconnected from the mains supply voltage. Wait a few seconds after switching off the device before you move the device or disconnect any equipment.

It is a necessity that you only use an approved extension and compatible wiring that is suitable for the electrical power consumption of the installed equipment. Please ensure that the electrical power supply corresponds with the voltage on the electrical identification plate at the back of the device.

## Operating Environment

Do not install this equipment in a confined space such as a bookcase or similar unit.

Do not use the set near damp, and cold areas, protect the set from overheating.

Keep away from direct sunlight.

Do not use the set near dust place.

Do not place candles near the opening area, to avoid flammable foreign material from entering the device.

## WEEE Directive



Correct Disposal of this product. This marking indicates that this product should not be disposed with other household wastes throughout the EU. To prevent possible harm to the environment or human health from uncontrolled waste disposal, recycle it responsibly to promote the sustainable reuse of material resources. To return your used device, please use the return and collection systems or contact the retailer where the product was purchased. They can take this product for environmentally safe recycling.

## 1.2 Storage

Your device has been carefully checked and packed before shipping. When unpacking it, make sure that all the parts are included and keep the packaging away from children. We recommend that you keep the carton during the warranty period, to keep your device perfectly protected in the event of repair or warranty.

## 1.3 Equipment Set-up

We recommend you to consult a professional installer to set up your equipment. Otherwise, please follow the instructions below:

Refer to the user manual of your TV and your antenna.

Make sure that the HDMI cable and outdoor components are in a good condition and the HDMI connections are well shielded and from good quality.

This user manual provides complete instructions for installing and using this receiver. The symbols serve as follows.

**WARNING:** Indicates warning information.

**NOTE:** Indicates any other additional important or helpful information.

**MENU** Represents a button on the remote control or the receiver. (**BOLD CHARACTERS**)

*Move to* Represents a menu item within a screen. (*Italic characters*)

## 1.4 Accessories

- 1x IR extender
- 1x IEC to SMA adapter
- 1x Micro USB Y- cable
- 1x HDMI adapter cable



- 1x remote control
- 2x AAA batteries
- 1x installation instructions
- 1x Double sided sticker

**WARNING:**

The batteries should not be recharged, disassembled, electrically short-circuited, be mixed or used with other types of batteries. If rechargeable accumulators instead of batteries are going to be used, we recommend using (e.g. NiMH) types with low self-discharge to ensure long time operation of remote control.

## 1.5 Usage of external USB devices

- The unit is only compatible with USB2.0 HDD (Hard Disk Drive). USB 3.0 and/or SSD (Solid State Drive) are not supported. If your device is not compatible to USB 2.0 specifications, the playback with your receiver might not work properly or not work at all.
- If you are going to use external USB HDD (Hard Disk Drive) please consider that the power specifications might exceed the supported output of your receiver (5 V/500 mA). If so, please connect your USB HDD to an according external power adapter.
- STRONG cannot guarantee compatibility with all types of USB storage devices.
- It is advised not to store important information on USB storage devices used with the receiver. Always make backups of data on your USB storage device before using it with this receiver. STRONG will not take responsibility for any loss of information or circumstances caused by loss of information.
- Please ensure that either the USB device is already formatted to NTFS or FAT32 or format the USB device via your receiver. Formatting requires entering the PIN code (default **1234**)
- STRONG cannot guarantee the playback of all files although extensions are listed, as it depends on file size, codec, bit rate and resolution.

## 2.0 YOUR RECEIVER

### 2.1 PIN-CODE DEFAULT: 1234

### 2.2 Side Panel

1. **TV (HDMI)**
2. **Micro USB:**
3. **IR extender**
4. **Antenna:**

To connect your receiver with your TV set using an HDMI extension cable or directly.

Connector for USB devices and power from TV USB.









Point your remote control towards this sensor.

To connect to your antenna for the reception of broadcast signal, using the IEC adapter.

*Fig. 1*

## 2.3 Remote Control

Fig. 2

1. 	Turns the receiver On/Standby
2. INFO	Shows the actual channel information
3. SLEEP	Press <b>SLEEP</b> repeatedly to select an automatic switch off time
4. 	Mutes audio output of the receiver
5. AUDIO	Sets the current audio channel to left, right or stereo
6. SUB	Shows list of subtitled languages
7. PG+/PG-	Page up/down and 10 channels steps in channel list mode
8. EPG	Shows the EPG (Electronic Programme Guide) in TV mode
9. TEXT	Shows Teletext on OSD (On Screen Display)
10. MENU	Opens the main menu. In menu you will get one step back
11. EXIT	Exits from the menu or sub-menu
12. 	Menu Off: Change channel to previous/next. Menu On: Moves the cursor up/down.
13. 	Menu Off: Increases/decreases the volume level. Menu On: Change settings for specific Menus
14. OK	Menu Off: Displays the current channel list Menu On: Activates the highlighted menu item. While in playback, select a time to jump to. Favourite group selection
15. GOTO	
16. FAV	
17. TV/R	Toggles between TV or RADIO mode
18. RECALL	Back to previous shown channel, in menu, one step back.
19. 0-9	Channel selection or value input
20. 	Records the TV programme to the connected storage device
21. 	Start playback in Multimedia, Start Playback of Timeshift
22. 	Activates the Timeshift function
23. 	Fast rewind/Fast forward
24. 	Previous/Next item in Multimedia.
25. COLOURED BUTTONS	For Editing in menu, Multimedia and Teletext functions. Follow on screen suggestions. Combined on coloured buttons:
26. ZOOM	Zoom in Multimedia Picture show.
27. ASPECT	Change aspect ratio of the video, default is Auto.
28. V.F.	Change the video format of the video.
29. TIMER	See an overview and/or edit the timer schedule

## 2.4 Installing the batteries

Fig. 3

Open the cover on the remote control and insert 2x AAA type batteries into the compartment. Observe correct polarity of the batteries when inserting. A terminal diagram is shown inside the compartment.

1. Remove the cover.
2. Insert the batteries.
3. Place the cover.

## 2.5 Using the remote control and the IR extender.

Connect the external IR extender to the unit at the IR connector and place the sensor end somewhere convenient, where it can be “seen” by the Remote Control, for example on the TV front panels bezel. Use the provided double sided sticker.

*Fig. 4*

To use the remote control, point it towards the external IR extender. The remote control supports a range of up to 5 meters distance to the receiver at an angle of up to approx. 30 degrees.

**NOTE:**

Managing the receiver will be limited or not possible if there are obstacles between the remote control sensor and the remote control. Direct sunlight or very bright light can reduce or disturb the reception of the remote control signals.

## 3.0 CONNECTION

### 3.1 Connecting to a terrestrial antenna

*Fig. 5*

To receive broadcast signal, your terrestrial indoor or outdoor antenna must be connected to the RF IN connector of the receiver. Use a properly shielded antenna cable and suitable connectors. Use the provided SMA to IEC adapter to connect your antenna.

### 3.2 Connecting to TV with HDMI extender cable or directly to HDMI port.

*Fig. 5*

The TV set can be connected with the receiver using the provided HDMI extender cable. If enough spacing left between HDMI inputs and sufficient space is available to accommodate the various cables, then the receiver can also be inserted directly in to an HDMI port of the TV. Proceed with care, no physical tension should occur to the TV or receiver once inserted.

### 3.3 Connecting a USB storage device

*Fig. 6*

**NOTE:**

We recommend the use of a hard disk drive USB 2.0 or higher for recording and play back of TV events.

Use the provided Y-cable (USB-A female at one end, USB-A male and USB-micro to each of the legs). Connect the USB A plug to the USB port on your TV that is suitable for supplying power to external devices (5V and 0.9A) and connect the USB micro plug to the receiver.

The USB-S female can be used to connect an optional external HDD. The HDD will thus be powered by the TV, not by the receiver.

For proper functioning of Timeshift and recording functions, a fast USB device (such as a hard disk drive) is needed. Interrupted playback or a distorted picture during playback or Timeshift are

indications for a low device speed. STRONG cannot guarantee proper functioning of recording and or Timeshift functions with all USB devices.

## 4.0 STARTING UP FOR THE FIRST TIME

If you use your receiver for the first time, the *Installation Guide* menu appears. Use ▲▼ to move the highlight to the setting you wish to change and use ◀▶ to change values. Start by selecting your On-Screen Language (OSD) using ◀▶. Once you have selected your language, press ▼ to move the highlight to *Country*. Select your country using ◀▶.

Other options are:

- Antenna Power:* Set to *On* if you use an active antenna. When set to *On*, a 5 Volt power will be present on the RF IN connector of the receiver. Select *Off* for passive antennas.
- Scan mode:* Select *All* to store scrambled and free to air channels or select *FTA* to store only Free-To-Air channels. Note: Scrambled channels you cannot watch with this receiver.

Once all settings are made, move the highlight to *Channel Search* and press **OK** to start scanning. The receiver will now search for all available channels. Once scanning is finished, the receiver switches to viewing mode.

**NOTE:** Selecting the wrong country may result in a disorderly channel list, and missing of channels.

**TIP:** In case the *Installation Guide* menu does not appear after switching on the receiver the first time, reset the receiver to factory settings by pressing the **MENU** button and selecting *Restore Factory Default* in submenu *System*. (Default PIN 1234)

## 5.0 QUICK GUIDE TO USING YOUR RECEIVER

We at STRONG understand that you can't wait to enjoy your new high definition digital terrestrial receiver. The following quick guide will make you familiar with the basic operation of this device. We do, however, advise you to read the full manual to get the best performance from your receiver. To turn your receiver ON or to Standby, use the ⏻ button on the remote control. Choose the desired channel with the ▲▼ buttons. Alternatively, you can digit the channel number with the 0~9 buttons on the remote control. Or press **OK** in viewing mode to display the channel list. The volume can be adjusted with the ◀▶ buttons. Default Password is 1234.

## 6.0 OPERATION

Your new receiver is equipped with several features to make watching TV a true pleasure. This paragraph describes these features. Please also read chapter 7.0 to get familiar with the menu of your receiver.

## 6.1 Changing channels

Your new receiver is equipped with four ways to change channels.

Via direct access using the 0~9 buttons.

Via the channel list through OK button.

Via the PG+ and PG- keys in (long) channel list.

Via the ▲▼ keys.

### 6.1.1 Direct access via 0~9 buttons

To gain direct access to a certain channel, simply input its number with the 0~9 keys on the remote control. Channel numbers can be up to four digits long. Entering a number with less than four digits is possible. Just wait a few seconds and your receiver will switch to the selected channel or press OK immediately after selecting the channel number.

### 6.1.2 Channel list

Press OK in viewing mode to display the Channel List. Use ▲▼ in the Channel List to highlight your channel of choice and press OK once to select the highlighted channel.

**TIP:**

Use ◀▶ to toggle between the *TV List* and *Radio List*, press FAV for a list of available favourite lists, toggle between them, also with ◀▶.

### 6.1.3 Using the ▲▼ or PG+/PG- keys

▲ switches to the next channel.

▼ switches to the previous channel.

In (long) channel list:

PG+ switches to the next 10 channels.

PG- switches to the previous 10 channels.

## 6.2 Info Banner

While watching TV you can press the INFO button any time to get information about the current channel and event\*. Press INFO twice for programme information and some technical details about the current channel.

\* Event information is displayed when available. Availability depends on broadcast.

## 6.3 Selection of audio language

Some channels support a choice of audio formats and/or languages. To select another audio stream, press AUDIO in viewing mode. A list with available audio streams will now be displayed. Use ▲▼ to select the desired stream and confirm with OK.

## 6.4 Teletext

Your receiver includes a fully featured Teletext. To access Teletext, press the TEXT button in viewing mode and use the 0~9 buttons to input the number of the page you wish to see. The coloured buttons of the remote control allow you to jump to selected pages immediately, as indicated on the bottom of the teletext screen. Use the ▲▼ buttons to select one page up or down, use ◀▶ buttons

to select subpages, if indicated at the bottom of the screen. Press **EXIT** or **TEXT** to get back to viewing mode.

## 6.5 Subtitles

Some channels support a choice of subtitle languages. Press **SUB** in viewing mode to display a list of available subtitle languages. Select your subtitle of choice with **▲▼** and press **OK** to confirm. Press **EXIT** to leave without making changes.

## 6.6 Timeshift

Timeshift allows you to pause live broadcasts and resume playback later. Press **II/TIMESHIFT** in viewing mode to activate this mode. On screen will appear a message (Entering Timeshift and picture will pause. Press **II** or **PLAY** to resume time-shifted playback. A time banner will show, to indicate the time offset from live TV. Press **EXIT** to remove the banner. Use **◀▶** for Fast rewind/Fast forwards. Press **■** to return to live TV.

**NOTE:** Timeshift needs a connected USB storage device with sufficient free space and sufficient speed in order to work properly.

## 6.7 EPG (Electronic Programme Guide)

The Electronic Programme Guide is a very useful function that allows you to view event schedules and information and to mark programmes for recording. To access the EPG, press the **EPG** button in viewing mode. Use **◀▶** to select the desired channel and **▲▼** to select the desired event. Use **EXIT** to quit the detailed information screen. Press **OK** to book a desired event automatically. It is possible to change the options manually. Make sure to have an HDD device connected, and select *Record* at the *Mode* option. Confirm with **OK**. Use the **COLOUR BUTTONS** to add, edit or delete an entry manually. Recordings will be stored in the Multimedia>PVR>HBPVR folder on your HDD drive. See chapter 7.2 for more detailed information.

**NOTE:** Availability of EPG data depends on broadcast.

## 6.8 Instant Recording

Your new receiver allows you to make an instant recording of the programme you are watching. Simply press **●** to start the recording.

During the recording a recording sign will be shown on the upper left of your TV screen. To stop the recording, press **■**. Select **Yes** and press **OK** again to stop the recording.

\* Please connect a USB storage device with sufficient free space before you start a recording.

Recordings will be stored in the Multimedia>PVR>HBPVR folder on your HDD drive.

## 6.9 Sleep

Press **SLEEP** repeatedly to select an automatic switch off time, at which the unit will go to standby. Default is **OFF**.

## 7.0 MAIN MENU

The main menu gives you access to settings and multimedia functions. To access the main menu, press **MENU** in viewing mode. The main menu consists of the following sub menus: *Programme, Picture, Channel Search, Time, Option, System* and *USB*. Throughout the main menu, **MENU** or **EXIT** can be used to get back to the previous screen. Use ◀▶ and **OK** to select or to change settings. Use the button suggestions at the bottom of the screen available for certain functions. For some menu items a valid Password it is necessary to access the item. Default Password is 1234.

### 7.1 Programme

#### Programme Edit

To access this menu, you must enter a valid Password. The procedures are equal for the *DVBT TV List* and *DVBT Radio List*. Use ◀▶ to change between the TV and Radio lists.

**NOTE:** For successful editing of channel list, switch Off LCN function. See ch. 7.3

#### Moving channels

Use ▲▼ to select a channel and press **RED** to select it to be moved. Now you can move the selected channel up or down inside the channel list by using ▲▼. When the channel is on the position of your choice, press **OK** again. The channel is now fixed on its new position. When all changes have been made, press **EXIT**. A saving banner will pop up.

#### Skipping channels

Channels marked with *Skip* will be skipped when zapping channels with the ▲▼ buttons. The channels will still be available from the channel list.

Use ▲▼ to select a channel and press **GREEN** to mark or unmark it for skipping. Channels set for skipping will be marked with the **SKIP\_IMG** symbol. When all changes have been made, press **EXIT**. A Saving banner will pop up.

#### Locking channels

Locked channels can only be watched after entering the password. (**DEFAULT PASSWORD: 1234**) Press ▲▼ to select a channel and press **YELLOW** to lock or unlock it. You are asked to enter the PIN code. Locked channels will be marked with the **🔒** symbol. Locking/unlocking multiple channels in one session is possible. When all changes have been made, press **EXIT**. A Saving banner will pop up.

#### Delete

Use ▲▼ to highlight a channel and press **BLUE** to mark it for deletion. When you have marked the channel you wish to delete, a confirmation banner will be displayed. Select **OK** to delete the marked channel or *Exit* to cancel. Press **EXIT** after finishing.

**NOTE:** Deleted channels can only be retrieved if you do a frequency scan in the *Channel Search* menu again.

### Adding channels to favourite lists

Channels from the can be added to up to 4 different favourite groups. Press **FAV** in *Programme Edit* to access the function. Use **▲▼** to select a channel you wish to add to a favourite group. When the highlight is on the channel of your choice, press **FAV**. A Favourite Type can be selected from the pop-up list. Use **▲▼** to select the favourite list you wish to add the channel to and press **OK**, press **EXIT** to finalize the process. Favourite channels will be marked with a star symbol. When all changes have been made, press **EXIT**. A Saving banner will pop up.

To de-select a channel from a Favourite list, repeat the above procedure, but select **Disable** from the pop-up list.

### Rename

Use **▲▼** to select a channel you wish to rename. Then press *Recall*. A pop-up keyboard will show on screen. Use **◀▶ ▲▼** to select characters/functions and enter them with **OK**. When you have finished editing, select **OK** to enter the changes. When all changes have been made, press **EXIT**.

## 7.2 EPG (Electronic Programme Guide)

The Electronic Programme Guide is a very useful function that allows you to view event schedules and programme information and to mark events/movies for recording. To access the EPG, press the **EPG** button in viewing mode or select it from the Main menu in the *Programme* section. Use **◀▶** to select a channel and **▲▼** to select an event. Detailed information of the selected event will show in the right-hand window. If more than one information page is available, use **YELLOW** and/or **BLUE** to access it. To mark the event for recording, press **OK**. A pop-up entry field will appear. Check if the entry is as you wished, all items can be changed if needed. For recording it is important to change the Mode from **View** to **Record**, otherwise, the unit will only wake up at the selected time. Press **OK** to confirm the timer for a selected event. The Schedule overview will show. Use the suggested buttons at the bottom of the screen to *Add manually*, *Edit*, or *Delete* a timer.

**NOTE:** Availability of EPG data depends on broadcast.

**NOTE:** An event can only be recorded if a suitable USB device is connected.

## 7.3 LCN (Logical Channel Numbering)

If *LCN* (Logical Channel Numbering) is activated and an LCN signal is provided by the broadcaster, channels will be stored in a broadcaster defined order. Set *LCN* to *On* to activate broadcaster defined channel numbering or *Off* to store channels in found order. This function only applies when a new channel search is performed.



**NOTE:** For successful editing of channel list (see ch 7.1), switch Off LCN function.

## 7.4 Picture

Use this menu to match your receiver to your TV set.

The following settings are available:

<i>Aspect Ratio:</i>	Select the aspect ratio that matches your TV. The options are:
<i>Auto</i>	In most cases this default setting should suffice, but it can be changed to cope with broadcast errors or personal taste.
<i>16:9 widescreen</i>	A 4:3 programme will be show full screen, with sideways stretched content.
<i>16:9 Pillarbox</i>	A 4:3 programme will be shown normally, but with black bars to the left and right.
<i>16:9 Pan&amp;Scan</i>	A 4:3 programme will be shown as a centre blow up to fill the whole screen, missing content to the left, right, top and bottom of the programme.
<i>Resolution</i>	If the video quality does not appear correctly, change the setting. These settings match the most common settings for HDMI.
<i>576p:</i>	For digital SD TVs (some digital TVs do not support this mode).
<i>720p:</i>	For digital HD TVs (on HDMI connection).
<i>1080i:</i>	For digital HD TVs (on HDMI connection).
<i>1080p (50 Hz):</i>	For digital HD TVs (on HDMI connection).
<i>Auto:</i>	The best possible resolution available will be auto negotiated by between TV and receiver ('handshake') when using a modern digital HD TV when connected with an HDMI cable.
<i>TV Format</i>	Options are <i>PAL</i> and <i>NTSC</i> . For European broadcasts, the TV format is <i>PAL</i> (Default).

## 7.5 Channel Search

<i>Auto Search</i>	This menu allows you to search for channels from all available frequencies for your selected region automatically. Be aware that all previous installed channels and favourite list(s) will be deleted. The new-found channels will be installed in the channel list and afterwards you can create a new favourite list if you like. Press <b>OK</b> to start the scan.
<i>Manual Search</i>	Select a particular channel to do a search on just one (known) frequency. Press <b>OK</b> to start the scan. The signal quality bar might be useful to check if the frequency is indeed in use.
<i>Country</i>	Select the correct country where this receiver is used. If failing to do so, may result in that channels appear randomly in the channel list, instead of a more logical order.
<i>Antenna Power</i>	Set to <i>On</i> if you use an active antenna. When set to <i>On</i> , 5 V will be present at the <i>RF in</i> connector of the receiver. Select <i>Off</i> for passive antennas.
<i>Scan Mode</i>	Select between <i>FTA</i> (Free-To-Air), which will only install Free-to-Air channels or <i>All</i> , which will install all found channels, even if they are scrambled. Then select <i>Auto Search</i> or <i>Manual Search</i> and press <b>OK</b> to start scanning.

## 7.6 Time

Set up your time zone for clock/time in your menu and system.

*Time Offset*

The GMT time can automatically be determined from the incoming TV broadcast if set to *Auto*. The time zone is determined from the Country setting in the *Channel Search* menu. If set to *Manual*, you can change the Time zone yourself in the *Time Zone* option. Default is *Auto*.

*Time Zone*

If the correct time cannot be obtained from the incoming TV broadcast, change the *Time Zone* setting yourself.

*Auto Standby*

Example: in case of Daylight Saving Time.

As a power saving feature, the unit will switch to Standby automatically, if no command from the remote control is received for the set time. Options are *1 Hour, 2 Hour, 3 Hour, Off*. Default is 3 hours.

*Power On/Off*

You can set a time to automatically switch On and/or Off the unit every day. The unit will start on the last watched channel.

*Power On*

**Note:** Set *Auto Standby* function to *Off*.

*Power On Time*

Set to *Enable* if you want to use the automatically switch On function.

*Power Off*

Enter the switch On time with the numeric buttons on the remote control.

*Power Off Time*

Set to *Enable* if you want to use the automatically switch Off function.

Enter the switch Off time with the numeric buttons on the remote control.

## 7.7 Option

*OSD Language*

Set up the options for languages.

*Subtitle Language*

Use ◀▶ to select the language for the On-Screen Display.

*Audio Language*

Set your preference for the subtitle language priority, if available in broadcast.

*Digital Audio*

Set your preference for the audio language priority, if available in broadcast.

Options are: *Off, PCM, RAW HDMI On, RAW HDMI Off*

*PCM:* All audio will be down mixed to a Stereo format on HDMI and S/PDIF

outputs.

*RAW HDMI On:* Raw audio information will be passed on to the HDMI output, without down mixing to PCM Stereo, to be passed on to and processed by a digital amplifier or home-theatre set to produce multi-channel audio.

*RAW HDMI Off*

No audio will be forwarded to the outputs.

*Audio Description*

AD. Useful for the visual impaired. If you like to have support of an audio track that describes the content on screen, select the volume from the AD audio track. Default is *Off*.

### NOTE:

Audio Description depends on the broadcaster inserting such an accompanying audio track.

## 7.8 System

Setup some system own features for maintenance and protection.

*Parental Guidance*

Programmes with a Parental Guidance Rating can be blocked from viewing and opened only with a Password. To setup this feature, enter your password

	first. Then select an age, above which the channel must be protected. Options are: <i>Off</i> , <i>1 to 18</i> . Default is <i>Off</i> .
<i>Set password</i>	To set another password than the default one, enter the old 4-digit password first, then enter a new password and confirm it, by entering it again.
<i>Restore Factory Default</i>	Reset your receiver to the default factory settings. Sometimes useful if the unit suddenly behaves in an unexpected manner, e.g. after a power failure. Select <i>System</i> then <i>Restore Factory Default</i> in the main menu and press <b>OK</b> to select. Enter your password or the <b>DEFAULT password: 1234</b> and press <b>OK</b> to confirm. Note: This option will delete all your channels, Favourite lists and settings. The receiver will reboot and start with the initial <i>Installation</i> menu.
<i>Information</i>	This submenu shows receiver specific information such as hardware and software version. Please have the <i>Information</i> screen on hand when you call our hotline. The person who answers your call might ask for the information given in this screen.
<i>Software Update</i>	This feature allows you to update the receiver software via the USB port. When a new software is available for your receiver, it can be downloaded from our website. Place the software file (unzipped) in the root directory of your USB storage device (HDD, memory receiver etc.) and connect the device to the USB port of the receiver. First a message box will appear that a USB device is found. Then go to the <i>System</i> menu and select the <i>Software Update</i> option. Select the correct file in the list. Press <b>OK</b> to start update. When ready, the unit will reboot automatically.
<i>Recall List</i>	If set to <i>On</i> , a list of last watched channels will be displayed in viewing mode, when the <b>RECALL</b> button on the remote control is pressed. Choose the channel to go back to and press <b>OK</b> . If set to <i>Off</i> , the <b>RECALL</b> button will instantly return to the previous watched channel.

## 7.9 USB

### Multimedia

This function allows playback of different kind of files from the connected USB storage device. Select *Music* and press **OK** to playback MP3 files from your folders. Select *Photo* and press **OK** to view your favourite pictures in JPG format. Select *Movie* and press **OK** to enter to play a number of video formats. Select *PVR* and press **OK**, and select the *HBPVR* folder to show the recordings you've made. The unit supports USB HDD devices with FAT32 format. However, it is possible to use already on a PC formatted NTFS HDD device. Make sure your USB device is formatted correctly. Use the On-Screen button suggestions and the multimedia buttons like **RECALL** (Return), **▶**, **■** and **||** on the remote control to work inside the multi media player.

<i>Photo Configure</i>	Setup your preferences for Photo viewing. Press <b>▶</b> and photos will be shown in an automatic slide mode.
<i>Slide Time</i>	Time between advancing to the next photo.
<i>Slide Mode</i>	Many different modes can be used, for dissolving to the next photo, defined by a number. Also, it is possible to select <i>Random</i> order to view the photos.
<i>Movie Configure</i>	For Subtitle use in the movie player, setup the features here.
<i>Subtitle Specific</i>	Select either <i>normal</i> , <i>big</i> or <i>small</i> for Subtitle size.
<i>Subtitle BG</i>	Select the preferred colour of the Subtitle Background.

*Subtitle FontColor*

Select the preferred colour of the Subtitle characters.

*PVR Configure*

For this option to work, you must have a USB device connected.

*Record Device*

If your USB device should have more than 1 partition, select the one to use.

*Timeshift Size*

Select the amount of free space, to be assigned to the Timeshift function.

Default is 1GB, which would account for around 1 hour of video, depending on the video format and resolution.

**NOTE:**

Below this setting information is shown about the current partition or device.

*Format*

The use of a USB Hard Disk Drive, already formatted in a PC with FAT32 or NTFS is recommended.

**WARNING:**

The format function will delete all data and information from your USB device or selected partition. Manufacturer will not take any responsibility for damaged or lost data on the USB device.

If you have multiple partitions on your storage device, select the partition you would like to format and press **OK** to continue. A confirmation banner will now be displayed. Press **OK** to start formatting (or **EXIT** to cancel it). The format procedure will take some time, depending on the size of the used storage device. At the end of the process, the "Formatting is complete" message will appear. Press **EXIT** twice to exit the menu.

## 8.0 TROUBLESHOOTING

There may be various reasons for abnormal operation of the receiver. Check the receiver according to the procedures shown below. If the receiver does not work properly after checking it, please contact your dealer or the local Service Hotline or send email to our Support via [www.strong.tv](http://www.strong.tv). Do **NOT** try to open or disassemble the receiver. It may cause a dangerous situation and warranty will be void.

Problem	Possible cause	What to do
The LED/standby indicator and LED display (if available on your receiver) are not switching on. The external IR sensor is not working	The power cable or power adapter is unplugged.	Check that the power cable or power adapter is plugged to the wall outlet.
	If your receiver has a main power switch: The main power switch on the rear panel is set to <b>OFF</b> .	Switch the main power on.
	The external IR sensor is not working.	Check if the external IR sensor is (properly) connected.
	The electrical outlet may be damaged.	Check with another device if the electrical outlet is supplied.

Problem	Possible cause	What to do
No signal.	The receiver is not connected to the signal source (DVB-C) or to the antenna (terrestrial or satellite antenna).	Check the lead of the antenna or cable. Check that the coaxial cable is correctly fitted to the antenna input on the receiver.
	Damaged or defective connectors (IEC-connectors (DVB-T2)).	Check connectors for visible damage.
	The antenna (terrestrial or satellite) is damaged.	Check the antenna for visible damage.
	Out of digital signal area.	Check with your dealer or contact your local Service.
	An active antenna requires that the antenna power/external power is switched ON.	Switch the antenna power of the receiver ON/connect an external power source.
	Wrong direction of the antenna.	Check the signal strength and quality and adjust your antenna correctly, or contact your local Service.
	Multiswitch is defective or power cable or power adapter of Multiswitch is unplugged.	Check that the power cable or power adapter of Multiswitch is plugged to the wall outlet. Contact your local Service.
The picture and sound remain frozen, or macro blocks or similar distortion are visible on the screen.	The transmission signals are too weak or have reflections/interference. The antenna is not properly adjusted.	Press the <b>INFO</b> key on the remote control 3x to call up signal bars to visually assess signal strength and signal quality (both parameters should be visible in the last third of the infobars). Contact your local Service.

Problem	Possible cause	What to do
No sound on TV or amplifier.	The volume of the TV is set too low. The volume of the receiver is set too low.	Increase the volume of the TV with its remote control. Increase the volume of the receiver with its remote control.
	The correct input is not selected on your TV or amplifier, or the unit is set to a higher resolution than supported by the TV.	Switch to the correct TV/amplifier input.
		Select lower resolution on the receiver.
	The TV, digital receiver or amplifier is not switched on.	Switch the TV/digital receiver/ amplifier on.
	The TV or digital receiver is not connected to the mains.	Check the mains lead.
	Bad cable connection.	Make sure that any existing digital or analogue A/V cable connections between the used equipment (TV, digital receiver or A/V amplifier) are properly connected.
	Audio is muted.	Press the  button on your remote control.
The TV power is off.	Turn the TV on.	
No access to scrambled services.	The channel is scrambled. Your receiver doesn't support scrambled channels.	Select an alternative channel.
No response to the remote control.	The receiver is off.	Plug in and turn on the receiver.
	The remote control is not aimed correctly.	Aim the remote control at the IR sensor on the front panel of the receiver.
	The IR sensor on the front panel of the receiver is obstructed.	Avoid or remove obstructions.
	The batteries of the remote control are not inserted, wrongly inserted or exhausted.	Check whether the batteries are inserted correctly or exhausted. If exhausted, replace the batteries in the remote control.

Problem	Possible cause	What to do
After moving the DVB-T2 receiver to another room/area you are no longer able to receive digital reception.	The antenna signals are too weak.	Press <b>INFO</b> on the remote control to keep the signal bars on screen and adjust the Indoor antenna for maximum reception. Alternatively, do a rescan of the channels.
	The signal strength/quality might be less than before, if using an indoor antenna.	When using an active antenna, check if the antenna power setting is <i>On</i> . Try using an outdoor antenna.
The receiver switches off or to standby automatically.	The <i>Auto Standby</i> function is enabled and has reached the set time.	Disable <i>Auto Standby</i> . Refer to the user manual of your receiver for details.
Forgotten code/password.		The default PIN is <b>0000</b> or <b>1234</b> (refer to the user manual of your Device).
		Contact your local Service Hotline or send an email to our Support via <a href="http://www.strong.tv">www.strong.tv</a>
Forgotten channel lock code.		Contact your local Service Hotline or send an email to our Support via <a href="http://www.strong.tv">www.strong.tv</a>
Playback of video (or Timeshift) is causing picture freeze/macro blocks or similar distortion, especially on HD content.	The read/write speed of your USB device could be too low.	Make sure to use a USB storage device with sufficient speed and space. Pen drives ('USB receivers') may not support sufficient speed.
The USB storage device is not working properly.	The power consumption is too high.	Connect an extra power supply adapter to your USB HDD device.
	The USB device is formatted incorrectly.	Format the USB device on a PC to FAT 32.
Recording is no longer possible.	The selected storage medium is full.	Delete existing recording(s). Attach and use another storage medium.
The receiver automatically switches off after a certain time.	The <i>Auto Standby</i> function is enabled.	Check the <i>Auto Standby</i> setting and disable if necessary.

## 9.0 TECHNICAL SPECIFICATIONS

### Demodulator:

Demodulator:	DVB-T/T2 COFDM; 16 QAM/64 QAM; QPSK; 128/256QAM
Transmission mode:	2 K - 8 K

### Video Decoder:

Profile level:	HEVC (H265) AVC/H.264HP@L4.1, MPEG-4 ASP supported
Video resolution:	480i, 480p, 576i, 576p, 720p, 1080i, 1080p
Decoding:	PAL/NTSC
Aspect ratio:	4:3 Letterbox, 4:3 Pan & Scan, 16:9 Widescreen, Auto

### Audio Decoder:

Audio support:	Dolby Digital Plus*/AC3+/PCM
MPEG MusiCam Layer II	
Sampling rate:	32, 44.1, 48 KHz
Audio mode:	Stereo, Multi-Audio

\* Dolby Digital Plus, Dolby Audio and the double-D symbol are registered trademarks of Dolby Laboratories.

### Tuner:

Front End:	DVB-T/T2, UHF & VHF Tuner
Input frequency range:	174 – 230 MHz (VHF) and 470 - 790 MHz (UHF)
Input signal level:	-20 ~ -82 dBm
Antenna power:	5 V DC, max. 50 mA, short cut protected

### Memory and System:

Flash memory:	4 MB
SDRAM:	64 MB

### Connectors:

ANT IN - SMA to IEC adapter (female)
HDMI
Micro USB port: 5 V/500 mA (max.) supported
IR

### General Data:

Power consumption:	2.5 (max)
Power consumption in standby:	<0.5 W
Operating temperature:	0 ~ +40° C
Storage temperature:	-25 ~ +60° C
Operating humidity range:	10 ~ 85%, RH, Non-condensing
Size (WxDxH) in mm:	102 x 28 x 12
Weight:	0.120 kg