

# STRONG

## SRT420 | androidtv



### 2 IN 1 SMART TV BOX

### ANDROID TV™ AND TERRESTRIAL RECEIVER



Picture similar

Bedienungsanleitung  
Manuel d'utilisation  
Manuale utente  
Manual del usuario  
Manual do utilizador  
Használati útmutató  
Užívateľský manuál

Brugervejledning  
Brukerveiledning  
Gebruiksaanwijzing  
Användarhandbok  
Korisnički priručnik  
Ръководство на потребителя  
Посібник користувача

# SERVICE CENTER

AT	  <b>support_at@strong.tv</b> 0820 400 150 (€ 0,12/Min. österr. Festnetz)	HU	  <b>support_hu@strong.tv</b> +36 1 445 26 10
BG	  <b>support_bg@strong.tv</b> +359 32 634451	IT	  <b>support_it@strong.tv</b> 199 404 032 <b>Da rete fissa</b> 24,8 cent. al min. 12,5 cent. scatto alla risposta <b>Da rete mobile</b> max 49 cent. al min. 15,6 cent. scatto allo risposta
CZ	  <b>support_cz@strong.tv</b> 844 44 44 90	NL	  <b>support_nl@strong.tv</b>
DE	  <b>support_de@strong.tv</b> 0180 501 49 91 (€ 0,14/Min. deutsches Festnetz) (€ 0,42/Min. max. Mobilfunknetze)	PL	  <b>support_pl@strong.tv</b> 801 702 017
DK	  <b>support_dk@strong.tv</b>	PT	  <b>support_pt@strong.tv</b> +351 2 100 06 125
ES	  <b>support_es@strong.tv</b> +34 91 119 61 76	SK	  <b>support_sk@strong.tv</b> 0850 15 05 50
FR	  <b>support_fr@strong.tv</b>	SL	  <b>+386 1 828 08 58</b>
HR	  <b>+385 1 344 57 66</b>	UA	  <b>support_ua@strong.tv</b> +380 (44) 238 61 50

Supplied by STRONG Austria  
Represented by STRONG Ges.m.b.H.  
Teinfaltstraße 8/4.Stock A-1010 Vienna, Austria  
Email: support\_at@strong.tv

## LICENSES

This product contains one or more programs protected under international and U.S. copyright laws as unpublished works. They are confidential and proprietary to **Dolby Laboratories**. Their reproduction or disclosure, in whole or in part, or the production of derivative works therefrom without the express permission of Dolby Laboratories is prohibited. Copyright 2003-2009 by Dolby Laboratories. All rights reserved.

## SIMPLIFIED EU DECLARATION OF CONFORMITY

Hereby, STRONG declares that the device SRT 420 is in compliance with Directive 2014/53/EU.

The full text of the EU declaration of conformity is available at the following internet address:

<https://www.strong.tv/en/doc>

Subject to alterations. In consequence of continuous research and development technical specifications, design and appearance of products may change. Google, Google Play, YouTube, Android TV and other marks are trademarks of Google LLC. Wi-Fi is a registered trademark of Wi-Fi Alliance®. Skype is a trade mark of Skype and STRONG is not affiliated, sponsored, authorised or otherwise associated by/with the Skype group of companies. Manufactured under license from Dolby Laboratories. Dolby, Dolby Audio and the double-D symbol are trademarks of Dolby Laboratories. The terms HDMI, HDMI High-Definition Multimedia Interface, and the HDMI Logo are trademarks or registered trademarks of HDMI Licensing Administrator, Inc. All other product names are trademarks or registered trademarks of their respective owners.

© STRONG 2023. All rights reserved.

## TABLE DES MATIÈRES

<b>1.0 INTRODUCTION</b>	<b>4</b>
1.1 Safety Instructions	4
1.2 Equipment Set-up	5
1.3 Package content	5
1.4 Usage of external USB devices	5
<b>2.0 TV BOX PANELS</b>	<b>5</b>
2.1 Front Panel	5
2.2 Side Panel	6
2.3 Rear Panel	6
2.4 Remote control	6
2.5 Installing the batteries	7
<b>3.0 CONNECTION GUIDE</b>	<b>8</b>
<b>4.0 SETTING UP YOUR DEVICE</b>	<b>9</b>
4.1 First Installation	9
<b>5.0 USING LIVE TV</b>	<b>12</b>
<b>6.0 PREFERENCES SETUP LIVE TV</b>	<b>12</b>
6.1 Channel scan	12
6.2 Channel edit	12
6.3 Default channel	12
6.4 LCN	12
6.5 Antenna power	13
6.6 Parental control	13
<b>7.0 PREFERENCES AUDIO / SUBTITLES LIVE TV</b>	<b>13</b>
<b>8.0 USING ANDROID</b>	<b>13</b>
<b>9.0 SETTINGS</b>	<b>13</b>
9.1 Set your device name	13
9.2 Channels and inputs	14
9.3 Network and Internet	14
9.4 Accounts and sign in	14
9.5 Apps	14
9.6 Device Preferences	14
9.6.1 About Information	14
9.6.2 Date and Time	14
9.6.3 Language Settings	14
9.6.4 Display and sound	14
9.7 Remote and accessories	15
9.8 Set up remote buttons	15

<b>10.0 GOOGLE ASSISTANT</b>	<b>15</b>
<b>11.0 FACTORY RESET</b>	<b>15</b>
<b>12.0 SIMPLE TROUBLESHOOTING</b>	<b>16</b>
<b>13.0 TECHNICAL SPECIFICATIONS</b>	<b>17</b>

## 1.0 INTRODUCTION

Thank you for choosing the 4K Ultra HD Android TV Box supplied by STRONG. It has been produced with the latest new technology and offers extensive entertainment and great versatility. We wish you many hours of new great experiences exploring the Android world!

### 1.1 Safety Instructions

Read all of the instructions before operating the device. Keep these instructions well for later use.

- Only use attachments/accessories specified or provided by the manufacturer (such as the exclusive supply adapter, battery etc.).
- Please refer to the information on the product enclosure for electrical and safety information before installing or operating the apparatus.
- To reduce the risk of fire or electric shock, do not expose this apparatus to rain or moisture.
- The ventilation should not be impeded by covering the ventilation openings with items, such as newspaper, table-cloths, curtains, etc.
- The apparatus shall not be exposed to dripping or splashing and no objects filled with liquids, such as vases, shall be placed on the apparatus.
- ⚠ This mark indicates a risk of electric shock.
- To prevent injury, this apparatus must be securely attached to the floor/wall in accordance with the installation instructions.
- Danger of explosion if the battery is incorrectly replaced. Replace only with the same or equivalent types.
- The battery (battery or batteries or battery pack) shall not be exposed to excessive heat such as sunshine, fire or the like.
- Excessive sound pressure from earphones and headphones can cause hearing loss.
- Listening to music at high volume levels and for extended durations can damage one's hearing.
- In order to reduce the risk of damage to hearing, one should lower the volume to a safe, comfortable level, and reduce the amount of time listening at high levels.
- The mains plug or appliance coupler is used as disconnect device, it shall remain readily operable. When not in use and during movement, please take care of the power cord set, e.g. tie up the power cord set with cable tie or something like that. It shall be free from sharp edges or similar which can cause abrasion of the power cord set. When put into use again, please make sure the power cord is not damaged. The absence of a light indication on the apparatus does not mean that it is fully disconnected from the mains. To disconnect the apparatus completely, the mains plug must be pulled out.
- Attention should be drawn to environmental aspects of battery disposal.
- No naked flame sources, such as lighted candles, should be placed on the apparatus.
- ⚠ To prevent the spread of fire, keep candles or other open flames away from this product at all times.
- Equipment with this symbol is a Class II or double insulated electrical appliance. It has been designed in such a way that it does not require a safety connection to electrical earth.

#### Precautions

- Never try to open the device. It is dangerous to touch the inside of the device due to high voltages and possible electrical hazards. Opening the device will void the warranty of the product. Refer all maintenance or servicing to suitably qualified personnel.
- When you are connecting cables, be sure that the device is disconnected from the mains supply voltage. Wait a few seconds after switching off the device before you move the device or disconnect any equipment.
- It is a necessity that you only use an approved extension and compatible wiring that is suitable for the electrical power consumption of the installed equipment. Please ensure that the electrical power supply corresponds with the voltage on the electrical identification plate at the back of the device.
- ⚠ Risk of explosion if the battery is replaced by an incorrect type.
- Disposing of a battery into the fire or a hot oven, or mechanically crushing or cutting a battery can result in an explosion.
- Leaving a battery in an extremely high temperature surrounding environment can result in an explosion or the leakage of flammable liquid or gas.
- A battery subjected to extremely low air pressure may result in an explosion or the leakage of flammable liquid or gas.

#### Operating Environment

- Do not install this equipment in a confined space such as a bookcase or similar unit.
- Do not use the set near damp, and cold areas, protect the set from overheating.
- Keep away from direct sunlight.
- Do not use the set near dust place.
- Do not place candles near the opening area, to avoid flammable foreign material from entering the device.

#### WEEE Directive



— Correct Disposal of this product. This marking indicates that this product should not be disposed with other household wastes throughout the EU. To prevent possible harm to the environment or human health from uncontrolled waste disposal,

recycle it responsibly to promote the sustainable reuse of material resources. To return your used device, please use the return and collection systems or contact the retailer where the product was purchased. They can take this product for environmental safe recycling.

## Storage

Your device has been carefully checked and packed before shipping. When unpacking it, make sure that all the parts are included and keep the packaging away from children. We recommend that you keep the carton during the warranty period, to keep your device perfectly protected in the event of repair or warranty.

## 1.2 Equipment Set-up

Please follow the instructions below:

Use only high quality, well shielded HDMI cable version 2.1 or higher to watch also in highest screen resolutions.

This user manual provides complete instructions for installing and using this product. The symbols will serve as follows:

**WARNING:** Indicates warning information.

**TIPS:** Indicates any other additional important or helpful information.

**MENU:** Represents a button on the remote control or the product.

**Move to:** Represents a menu item within a window.

## 1.3 Package content

- Android TV Box
- Voice Enabled Remote
- Power Adapter 12 V / 1 A
- HDMI Cable
- 2x AAA Batteries
- Installation instructions

**WARNING:** The batteries should not be recharged, disassembled, electrically short-circuited, be mixed or used with other types of batteries. If rechargeable accumulators instead of batteries are going to be used (e.g. NiMH), we recommend using types with low self-discharge to ensure long time operation of your remote control.

## 1.4 Usage of external USB devices

- It is recommended to use USB 2.0 storage devices or higher. If your device is not compatible to USB 2.0 specifications, playback and other functions of the product might not work properly.
- STRONG cannot guarantee compatibility with all types of USB devices such as web cams, keyboards, mouse devices, storage devices.
- If you are going to use external USB HDDs (Hard Disk Drives), please consider that power specifications may exceed the supported output of your box (max. 5 V/500 mA). If so, please connect your USB HDD to an external power adapter.
- It is advised not to store important information on USB storage devices used with the box. Always make backups of data on your USB storage device before using it with this box. STRONG will not take responsibility for any loss of information or circumstances caused by loss of information.

## 2.0 TV BOX PANELS

### 2.1 Front Panel

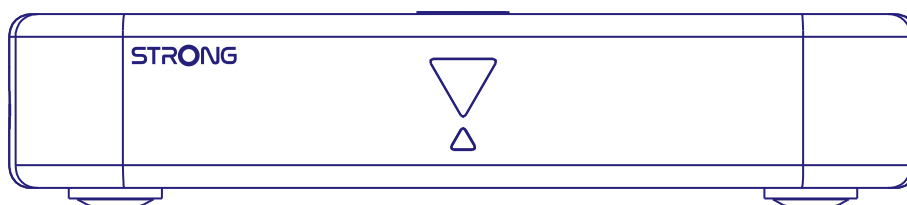

**Fig. 1**

**LED Indicator:** In standby mode it lights up in Red and in running mode it lights up in Blue color. If its blinking, then internet connection or Live TV data is not established or lost.

**Button on Top panel:** On/Off button

## 2.2 Side Panel

Fig. 2

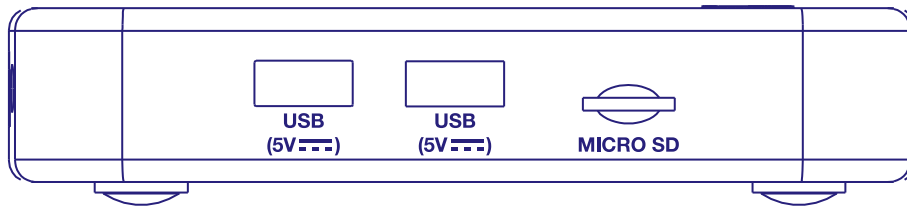

1. USB 2.0 Port
2. USB 2.0 Port
3. Micro SD card slot

## 2.3 Rear Panel

Fig. 3

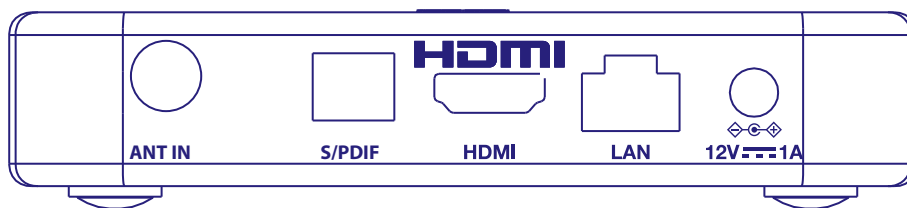

1. ANT IN
2. S/PDIF (optical)
3. HDMI (version 2.1)
4. LAN / ETHERNET RJ45
5. 12 V Adapter

To connect to your antenna for the reception of broadcast signal.

To connect to a digital or home cinema audio amplifier.

To connect your receiver with your TV set using a HDMI cable.

Connect to your Internet router to access the internet/apps.







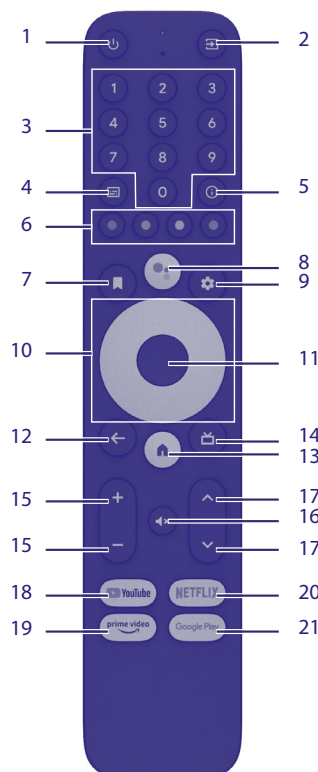





The receiver requires a wall adapter, mains voltage input 110~240V AC 50~60Hz 12V, 1.0 A DC output. Please check the local power conditions before connecting the receiver to the mains supply.

## 2.4 Remote control

Fig. 4





1.  Press to turn the Box on/off or standby.
2.  Press to access the TV sources.
3. 0 ~ 9 Choose channel directly.
4.  Subtitles /Audio selection
5. **INFO** Display information about the current source.
6. **COLOUR BUTTONS** Press to execute the prompt function in Live TV mode.
7.  Create play list or move app position
8.  Press to activate the voice control function\*.
9.  Press to access the Android TV settings.
10.  Navigate the menu.
11. **OK** Confirm the selection.
12.  Press to go back to previously menu or exit selection.
13.  Enter the home desktop.
14.  Press to open Live TV mode.
15. **VOL +/-** Adjust the volume up or down.
16.  Press to mute or restore the volume.
17.  Change programmes up or down.
18. **YOUTUBE** Press for direct access to YouTube.
19. **PRIME VIDEO** Press for direct access to prime video\*\*.
20. **NETFLIX** Press for direct access to Netflix\*\*\*
21. **GOOGLE PLAY** Press for direct access to Google Play.

\*Voice control and some other functions could work only when this RCU paired with your TV.

\*\* Membership is not included. Prime is available in selected countries. Streaming prime video requires to set up an account. Broadband Internet required. See [www.primevideo.com](http://www.primevideo.com) for details.

\*\*\*Membership is not included. Netflix is available in selected countries. Streaming Netflix requires to set up an account. Broadband Internet required. See [www.netflix.com/TermsOfUse](http://www.netflix.com/TermsOfUse) for details.

## 2.5 Installing the batteries

Open the cover on the remote control and insert 2x AAA batteries into the compartment. The correct position of batteries polar diagram is shown inside the batteries compartment.

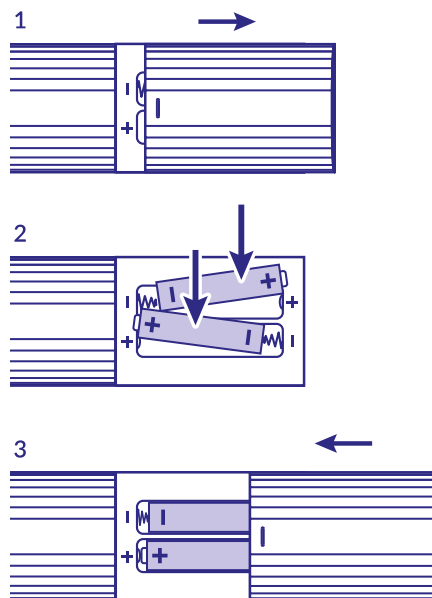

**Fig.5**

1. Open the cover.
2. Insert the batteries.
3. Close the lid.

### **WARNING:**

The batteries should not be recharged, disassembled, electrically short-circuited, be mixed or used with other types of batteries.

## 3.0 CONNECTION GUIDE

Refer to the diagram below for connecting your Android TV Box to power, network and other devices.

**NOTE:** Before getting started, please turn off all devices to be connected.)

Fig. 6

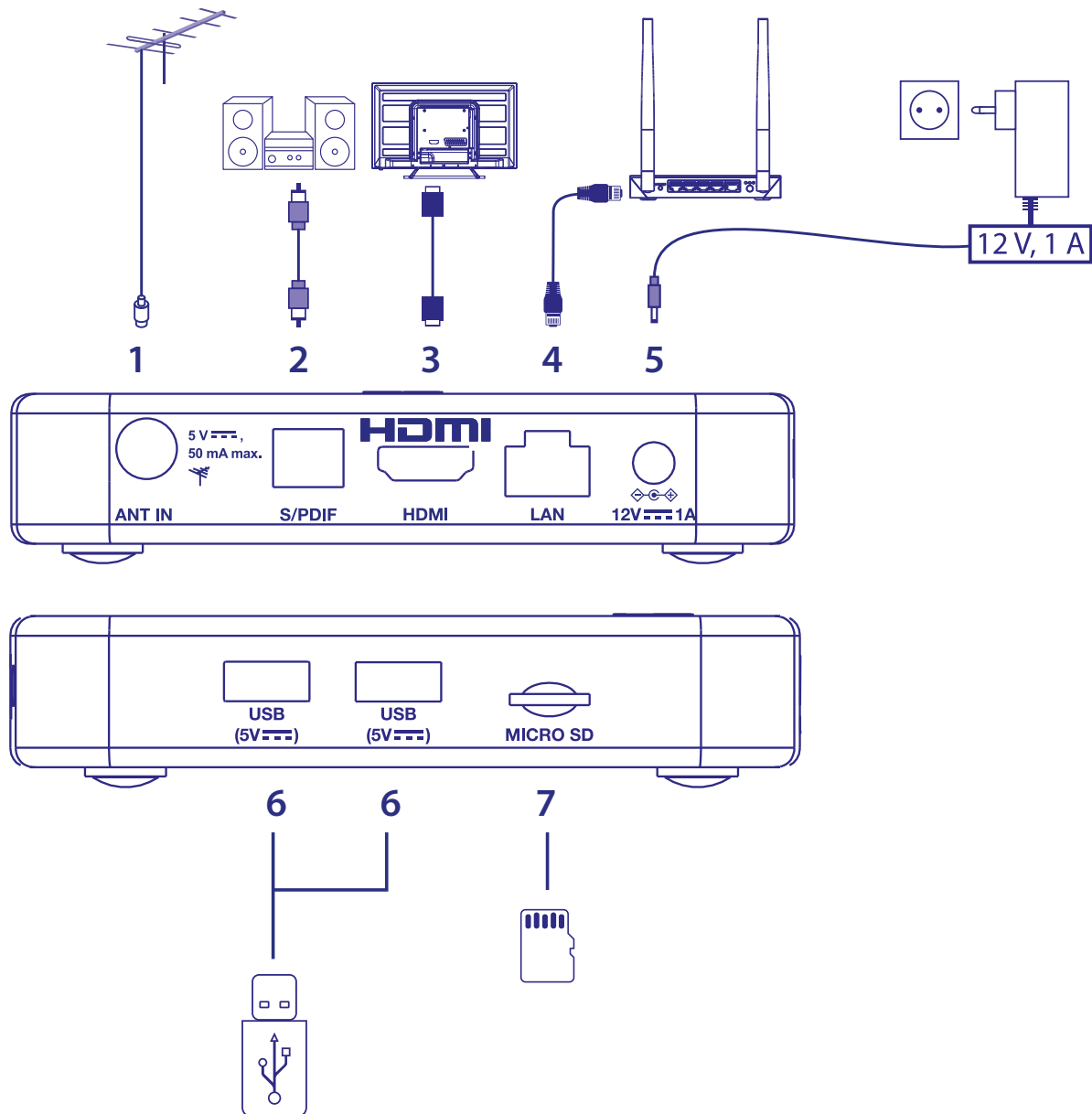

- 1. ANT IN
- 2. S/PDIF Optical
- 3. HDMI
- 4. ETHERNET
- 5. Power entree
- 6. USB
- 7. Micro SD card

- To connect to in or outdoor antenna for reception of broadcast signals.
- To connect to a digital home cinema set or digital audio amplifier
- To connect your receiver with your TV screen using an HDMI 2.1 cable.
- To connect to your router using an Ethernet / LAN cable (RJ-45)
- To connect to the included power adaptor 12V / 1Amp
- For connection of USB device for Multimedia use
- Here you insert the Micro SD Card

## 4.0 SETTING UP YOUR DEVICE

### Remote control pairing

You may turn on your devices after properly connecting all the hardware.

If all is properly connected and powered **On**, pairing screen will be showed on your TV screen.

When you do not see this screen, check if the correct HDMI input is selected on TV.

To be able to use Google Assistant on your remote control, you must first pair your Bluetooth Remote to your Android TV box. Follow the pairing instruction on the screen.

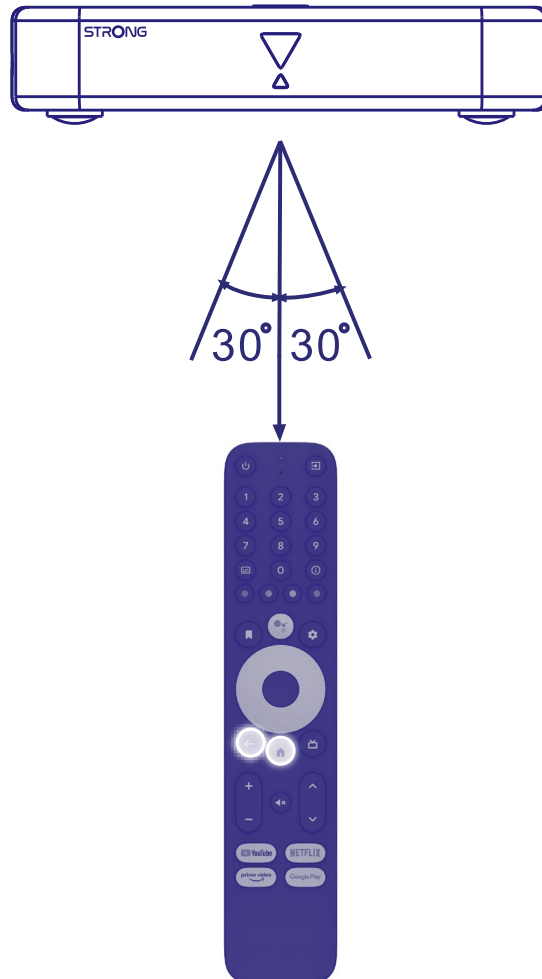

Press at the same time the **BACK** and **HOME** button for more than 5 seconds until the led on the remote control is blinking. When it was successful there will appear a message on screen. If not please check the batteries of the remote control or try it again.

### 4.1 First Installation

#### Step 1: Language

Select your preferred language on the Welcome Page.

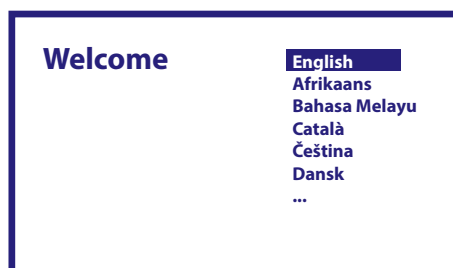

## Step 2: Wi-Fi

Select and connect to your Wi-Fi Network. If you are using Ethernet cable, then just confirm.



## Step 3: Google Account

Sign in with your Google Account. If you do not have one, please create one firstly on your computer or another android device as mobile phone or tablet. Without Google account you cannot use this device.

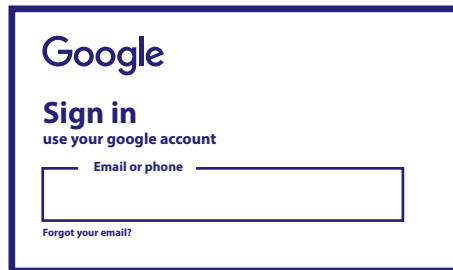

## Step 4: Terms of Service & Privacy Policy

Read and accept the Terms of Services & Privacy Policy.

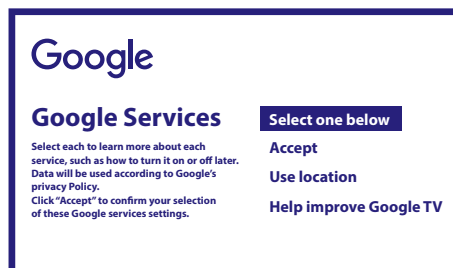

## Step 5: Meet your Google Assistant

Select in the next steps if you like to use Google Assistance and to use to search in applications.

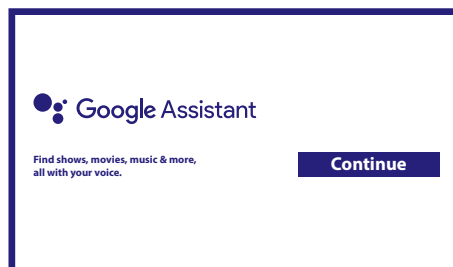

## Step 6: Select recommended apps

If you like to install advised applications you can select it here.

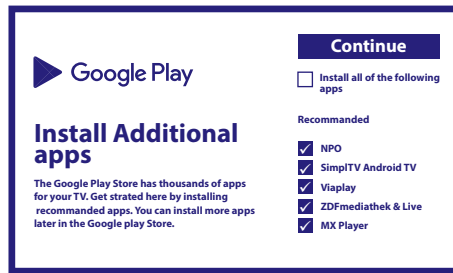

## Step 7: PIN number

In this step is to create a PIN number you can remember. This PIN will be used for parental control and lock of channels in the Live TV application. We do advice not to used 0000. Please, note this PIN number.

## Step 8: Tuner / scan

Select if you like to scan for TV and/or Radio channels. If not want to use this Live TV, then select "Skip". It is possible to do auto scan later on. If you select to use this, then you will enter country selection.

## Step 9: Choose country

Select here the country in which you are using the Android TV Box. It is very important to select the correct country as it depends on whether it finds all channels and sorts them automatically if this future is supported.

## Step 10: Tuning selection

In this menu you can select whether you want to use an active antenna that requires a 5 volt power supply for the built-in amplifier. Please check if the connected antenna requires this to be set to ON by pressing the **OK** button. Next, you can select the scan mode for "ALL" channels that are included scrambled or only "Free" to watch. Select "Auto Tuning" to start the scan on all frequencies or "Manual" for only one frequency.

If you wish, it is possible to tune the antenna first in manual tuning and then return to the start of automatic tuning.

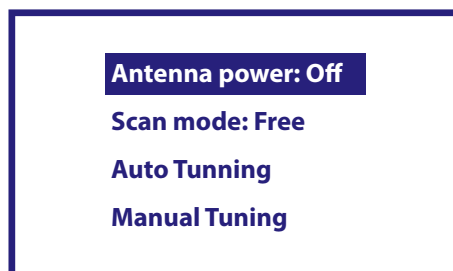

At end of selection, select "Auto Tuning" and press OK to start the scan process.

**NOTE:** This TV box cannot decode scrambled channels.

## Step 11: Set up remote

In this step, you can set up some buttons to adjust the volume, input and standby buttons of connected devices. For example: TV, soundbar, digital audio amplifier. To start, select "Set up remote control" and follow the instructions on the screen. To set up later at another time, simply select "Not now".

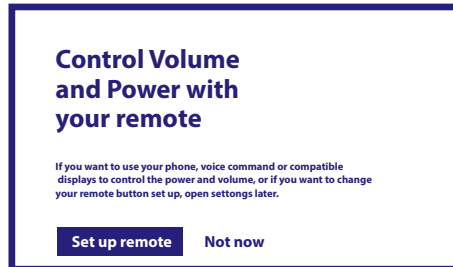

After all these steps, the Android TV box is displayed on the home screen. Select *Live TV* to watch the TV channels you have found. Now you can enjoy it as the installation is complete.

## 5.0 USING LIVE TV

To start watching the TV channels, select on home screen the *Live TV* application and press **OK**.

If the TV channels are found in the first installation steps, it will start to play on a channel.

When no channels are found during this first installation, then it will show the screen *Scan channels*. In this case press the **✳** button and select *Channels and inputs* to open the channel scan menu. Check if the correct country is selected. Select *Scan* menu and follow the instructions on screen to (re) install the TV channels.

When you use *Live TV* for the first time, the explanation from navigation buttons appears on screen. Use these buttons or press the **OK** button to go through these steps to confirm the explanations.

- ▲ Open the menu *For You* to select one of the currently running programs. In this menu use ◀▶ to select the TV guide, favorites or preferences.
- ▼ Information will show on screen from the currently running program. In this menu use ◀▶ to select Subtitle and Audio menu. Press **OK** to start Timeshift function when the USB device is connected.
- ◀ Open the channel list *All Channels*. In this menu use ▲▼ to move the highlight to another channel and press **OK** to select. Use ◀▶ to select *Recent* the last selected channels, only *Radio* or *TV* channels.
- ▶ Calling up the EPG information banner on the screen with only information about the current channel with current and upcoming events. Use ◀▶ to scroll to the next events and press **OK** to see more detailed information. If you want to see any of the next events, select *Watchlist* and press **OK** to add them to your watch list.
- ← Step back in the menu or exit the information.

**NOTE:** Some TV channels only transmit Dolby sound tracks. In this case, the volume cannot be adjusted via the volume control of the Android TV box. Instead, use the remote control of the TV screen or the Dolby audio amplifier. Alternatively, you can set up the volume control via the menu "**Settings**", "Set up remote control buttons" for control via the HDMI CEC protocol.

## 6.0 PREFERENCES SETUP LIVE TV

If you want to start a new automatic scan, edit channels, sort channels, set the default start channel or switch the antenna off and on, select the *Preferences* menu by clicking ▲ and four times ▶. Then click ▼ to select *Setup* and the submenus below.

### 6.1 Channel scan

This menu allows you to search for channels from all available frequencies for your selected country automatically. Be aware that all previous installed channels and favorite list(s) will be deleted. The newfound channels will be installed in the channel list and afterwards you can create a new favorite list if you like. Select *Scan* and select between *Auto*, which will install all found channels or *Manual*, to scan only on one selected frequency. Highlight *Search* and press **OK** to start scanning.

## 6.2 Channel edit

This menu allows to Skip, Move, Rename, Delete channels from the channel list.

- Skip channels:* Here you can mark these channels which you don't like to be shown during channel zapping.
- Move channels:* Select a channel you would like to move in channel list. Press shortly on **OK** to select and use **▲▼** to move to new position. Press shortly **OK** to confirm new position. Long press **OK** to access the option to go directly to the beginning or end of the channel list.
- Rename Channels:* You can change the current channel name to another one.
- Delete Channels:* You can permanently remove channels from the channel list.

## 6.3 Default channel

Use this menu item to select which channel to display when the Live TV App is launched. Set *On* to enable this, set *Off* to disable it and start with the last channel watched.

## 6.4 LCN

The *LCN* (Logical Channel Numbering) option can be switched OFF or ON. Select *Disabled / Off* if you want to sort the channels freely as you like. Select *Enabled / On* if the local transmitter supports this automatic channel sorting. If you change the LCN selection, a new automatic scan is recommended.

## 6.5 Antenna power

Set to *On* if you are using an active antenna (with built-in amplifier). The ANT IN connector of the receiver will then have 5 volts with max. 50mA. Select *Off* for passive antennas.

## 6.6 Parental control

This menu allows you to protect channels with Ratings levels and block channel with PIN. You can also create a new PIN code. To access this menu, type your PIN code firstly which you create during the first installation. Channels with a parental rating above the chosen age will be protected with a PIN code (if available in your local broadcast.)

- On / Off:* Press **OK** to switch Parental controls to *On* or *Off*.
- Program restrictions:* Choose in *Rating systems* the country(s) systems you want to use for control.
- Ratings:* Choose between *None, High, Medium, Low* restrictions.
- Custom:* To select manual and age rating restriction.
- Channels blocked:* Mark all programme/channels which you want to lock. You can select the lock separately for every channel which you would like to protect with a PIN code.
- Change PIN Code:* Press **OK** to enter this sub menu. Enter your current PIN code (4 digits). Enter your new PIN code (4 digits) you'd like to use.

Re-enter your new PIN code to confirm. It will be automatically saved.

Please, make a note of it. New PIN: \_\_\_\_\_

## 7.0 PREFERENCES AUDIO / SUBTITLES LIVE TV

For the priority settings of audio and subtitles, select one of these menus. In display mode, select the *Preferences* menu by clicking **▲** and four times **►**. Then click **▲** to select *Audio* or *Subtitles* and the submenus below.

### AUDIO

- 1st language:* Use **▲▼** to select the audio language you want to hear as first priority, if available.
- 2nd language:* Use **▲▼** to select a language that will be played when the language selected at *1st Audio language* isn't available.
- Audio description:* Select *Visually impaired* if you like to hear extra audio which describe what happening on running TV program. Kept to *Normal* without.

### SUBTITLES

- General:* Use **▲▼** to select *On* to activate displaying of subtitles.
- Normal:* For standard or *Hard of Hearing* subtitles\*
- 1st Subtitle Language:* Use **▲▼** to select the first preferred subtitle language.
- 2nd Subtitle Language:* Use **▲▼** to select the second preferred subtitle language.

\*The preferred subtitle type to be displayed automatically if available.

## 8.0 USING ANDROID

Press on the **HOME** button to select the android home page where you can start your journey.

This is the start page which allows you to select Live TV, your favourite applications as YouTube, to search for movies and new to be installed apps. Use the navigation buttons ▲▼ and ◀▶ to select and with **OK** confirm selection. To exit or one step back use **BACK** button.

Press **LIVE TV** button to open Live TV directly. (Chapter 5)

Press **SETTINGS** button to access directly android system menus to change settings and setup connections as Wi-Fi and Blue tooth. (Chapter 9)

Press **GOOGLE ASSISTANT** button to call Google Assistance with voice control functions. (Chapter 10)

## 9.0 SETTINGS

Select Settings to check the device information, add/remove accounts and make changes to the system settings. Remove apps, set date & time, select audio and screen settings, Factory reset and lot more... Press the \* button to access directly or through Home menu to select item in the upper right corner.

### 9.1 Set your device name

Select a name here that will help you identify the connection when you transmit or establish it from other devices.

### 9.2 Channels and inputs

This option is used to scan, skip and move channels for the Live TV app. Also accessible via the app.

### 9.3 Network and Internet

Select and enable Wi-Fi in order to connect wireless to the network.

Once the device scans and lists nearby Wi-Fi networks, select the appropriate network name, if required put in the password and select **OK**.

If you use an RJ45 cable between the Android box and the router for the Internet connection.

You can find under *Ethernet > Connected* whether the connection has been established correctly. If *Not Connected* is displayed, the cable is not plugged in or you want to use Wi-Fi instead.

**NOTE:** You can only use one connection at same time. Wi-Fi or Cable. Not both.

### 9.4 Accounts and sign in

Find here the current account you did use in first setup.

If you like to add a new account(s), then switch to new one or delete one.

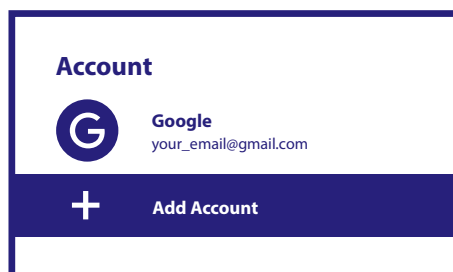

### 9.5 Apps

Find here all installed apps on your box. If you want you can remove them or see permission which access, they have or require. Please, be careful if you do change some or remove apps. This can lead to instability of their functions.



## 9.6 Device Preferences

Here you will find all settings such as information about the device and the software version, time and date, language selection, keyboard type, display and sound, storage space, activation of Google Assistance and Chromecast, energy saving settings, location and accessibility.

### 9.6.1 About Information

Under Settings > Device Preferences, select *About* to find device name and software information.

Select *System update* to check if a new software is available.

Select *Factory reset* to reset or to erase everything. (See Chapter 11)

**WARNING:** After an update the receiver restarts automatically. During the upgrade process NEVER disconnect the receiver from the mains or switch off the power! Doing so might damage your receiver and will void warranty!

### 9.6.2 Date and Time

Select *Date and Time* to change manual the time zone and the display format (24/12hour).

### 9.6.3 Language Settings

Select *Language* to change the language previously set.

### 9.6.4 Display and sound

Select *Display and sound* to change the Screen resolution, Audio formats and set up HDMI CEC Control.

By default, the screen resolution is automatically set to the best and maximum resolution of the connected TV. If you wish, you can switch to lower resolutions and switch off the HDR function. Select *HDMI CEC* to setup the control of the remote control from the devices and connected TV.

Select the *Advanced and Sound* settings to choose between stereo and Dolby audio and to activate the S/PDIF output.

Find under *Display and sound > Advanced sound settings > Select formats > None* to set only to Stereo audio. Select *Automatic* to use all audio formats supported by this device including Dolby Digital.

## 9.7 Remote and accessories

Select the option *Add accessory* for Bluetooth pairing of a new remote or device.

To remove, rename, find details of a Bluetooth device, choose this device which is shown under *Remote and accessories* and press **OK** to access.

## 9.8 Set up remote buttons

Select option *Add device* for control with included Android remote another device as TV, Soundbar or AV receiver. These must be connected by HDMI cable. Selections are Volume, Standby and Source input of TV screen. To setup these buttons need internet connection be active as codes will be controlled from internet server.

Please, follow the instruction on menus.

## 10.0 GOOGLE ASSISTANT

### Say it to Play it.

Ask it to play your favorite show, video, or music. Or find the latest blockbuster to enjoy.

To get started, press the Google Assistant button on your remote

Speak into the microphone of your Voice Search remote.

Learn more about the Google Assistant on [assistant.google.com](https://assistant.google.com) or say "What can you do?"

### Movies & TV shows:

Play Stranger Things on Netflix. Video clips: Play cat videos. Apps: Open YouTube. Search: Search for sitcoms.

Info: Tell me about Game of Thrones.

### Control

Playback: Pause. Stop. Resume Volume: Louder. Softer. Power: Turn off.

### Play music, news, or podcasts

Music: Play music by Sia. (Learn how to choose your music service provider.) News: Play the news. What's the latest news from BBC?

### Ask Google

Sports: How did the Patriots do? When is the next Warriors game? Calculations: What's 20% of 80?

Dictionary: What does “ludic” mean?

Find answers: How far away is the moon? What is weather in Berlin?

Unit conversions: How many teaspoons in a cup?

**NOTE:** To be able to use Google Assistant on your remote, you must first pair your Bluetooth Remote to your TV Box.

## 11.0 FACTORY RESET

Under Settings, select Device Preferences > About > Factory Reset.

Click Factory Reset to clear everything.

Once this option is selected, all manually installed apps and user data information will be deleted.

The Android TV box returns to the First Installation Wizard stage for a new installation.

**WARNING:** By resetting your Android TV box back to factory default, all your settings, installed application, accounts and stored channels will be permanently deleted. Please use this option with carefully.

Under Settings, select Device Preferences > About > Factory Reset.

Click Factory Reset to clear everything.

Once this option is selected, all manually installed apps and user data information will be deleted.

The Android TV box returns to the First Installation Wizard stage for a new installation.

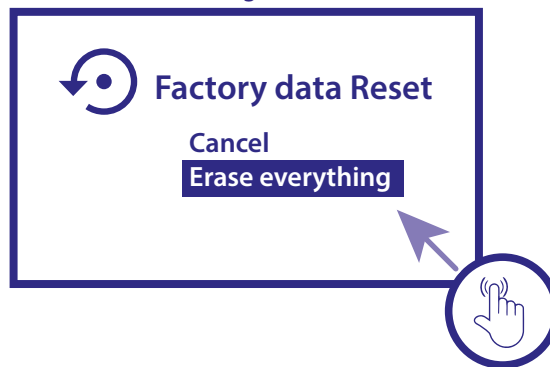

**WARNING:** By resetting your Android TV box back to factory default, all your settings, installed application, accounts and stored channels will be permanently deleted. Please use this option with carefully.

## 12.0 SIMPLE TROUBLESHOOTING

Issue	Possible Reason	Solution
No LED of menu display after power on	The power adapter is not properly connected	Make Sure the device is connected to the power
No Sound	<ul style="list-style-type: none"> <li>The Tv is on Mute or volume is low.</li> <li>The device is on Mute or the volume is too low.</li> </ul>	Press the mute button to restore the sound and increase the volume.
Failed to connect to network	<ul style="list-style-type: none"> <li>Ethernet cable is not properly connected.</li> <li>Wi-Fi is turned off or the signal is too weak.</li> </ul>	<ul style="list-style-type: none"> <li>Reconnect the cable.</li> <li>Restart the Wi-Fi or adjust the position of the device closer to the router.</li> </ul>
Remote Control Failure	<ul style="list-style-type: none"> <li>The remote is not paired.</li> <li>Remote control is broken or the batteries are low in power.</li> </ul>	<ul style="list-style-type: none"> <li>Aim the remote's sensor at the front panel's sensor and open settings &gt; Remotes and accessories &gt; Pair remote. Press <b>BACK &amp; HOME</b> at same time for 5 seconds.</li> <li>Replace batteries or send the device to the local maintenance service station for checking.</li> </ul>
No Picture on Screen	HDMI cable is not connected	Make sure that HDMI is selected as your TV input
Voice search on remote is not working	Remote is not paired to the TV Box	See the Pairing Bluetooth Device section in this guide

## 13.0 TECHNICAL SPECIFICATIONS

### Video decoder

Picture Quality:	HLG, HDR10, HDR10+
Video resolution:	3840 x 2160 (4Kp60, 4Kp30) 480i, 480p, 576i, 576p, 720p, 1080i, 1080p24, 1080p30, 1080p60
Video codecs:	10-bit H.265 (HEVC), VP9 Profile 2, H.264, AV 1.

### Audio decoder

Audio decoding:	Dolby® Digital/ Dolby® Digital Plus*, AAC, LC-AAC, HE-AAC, MP 3, MPEG-1 layer1/2
-----------------	--

\* Dolby, Dolby Audio and the double-D symbol are trademarks of Dolby Laboratories.

### System & Memory

Android Version:	11 Hailstorm
Chipset:	Amlogic S905Y4
CPU:	ARM Cortex-35 Quad Core 2004MHz
GPU:	Quad Core ARM Mali-G31@1800 MHz
SDRAM:	DDR4: 2 GB
Flash:	eMMC: 8 GB

### Connectors

ANT IN  
HDMI  
LAN  
2x USB ports version 2.0  
Micro SD port  
S/PDIF (optical)  
DC IN (12 V, 1 A)

## General data

Wi-Fi:	IEEE 802.11ac, 2.4 GHz IEEE 802.11ac, 5 GHz
Bluetooth:	5.0
Power supply:	110 - 240 V AC, 50/60 Hz
Input voltage:	DC 12 V, 1 A
Power consumption working:	7 W
Antenna power:	5Volt 50mA shortcut protected
Operating temperature range:	0 ~ +40 °C
Storage temperature:	-10 ~ +70 °C
Dimensions (W x D x H) in mm:	122 x 122 x 23
Weight:	170 g

## Data Protection:

Please be aware that STRONG, its manufacturing partners, the application providers and the providers of the services may collect and use technical data and related information, including but not limited to technical information about this device, system and application software and peripherals. STRONG, its manufacturing partners, the application providers and the providers of the services may use such information to improve its products or to provide services or technologies to you, as long as it is in a form that does not personally identify you.

Additionally, please keep in mind that some services provided - already in the device or installed by you - may request a registration for which you have to provide personal data.

Beside that, please be aware that some services which are not pre-installed but can be installed may collect personal data even without providing additional warnings and that STRONG cannot be held liable for a possible breach of data protection by services not pre-installed.

\* Availability of apps depending on the country. STRONG cannot be held liable for services by third parties. Offers by third parties may be changed or removed at any time, may not be available in all regions and may require a separate subscription.



