

STRONG

HD SMART Android TV with DVB-T2/C/S2
32HC4433



User Manual
Bedienungsanleitung
Manuel utilisateur
Manual del Usuario
Инструкции за употреба
Uživatelská příručka
Korisnički priručnik
Használati útmutató
Manuale utente

Gebruiksaanwijzing
Instrukcja obsługi
Manual do Utilizador
Manual de Utilizare
Uputstvo za upotrebu
Používateľská príručka
Navodila za uporabo
Посібник користувача
Руководство пользователя

Fig.1

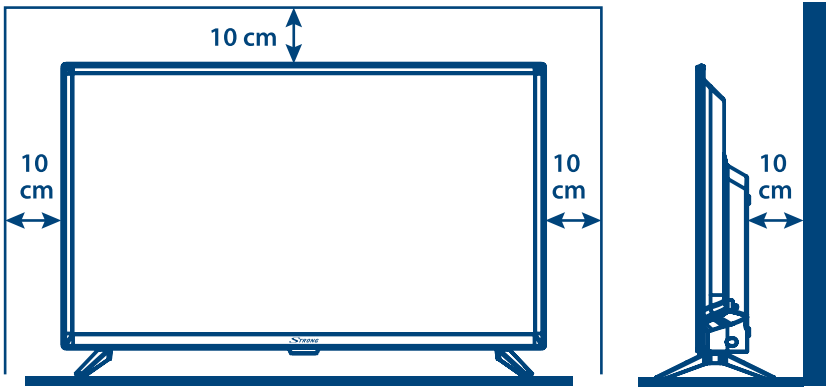

Fig.2

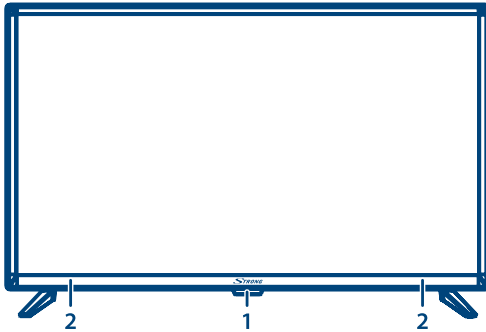

Fig.3a

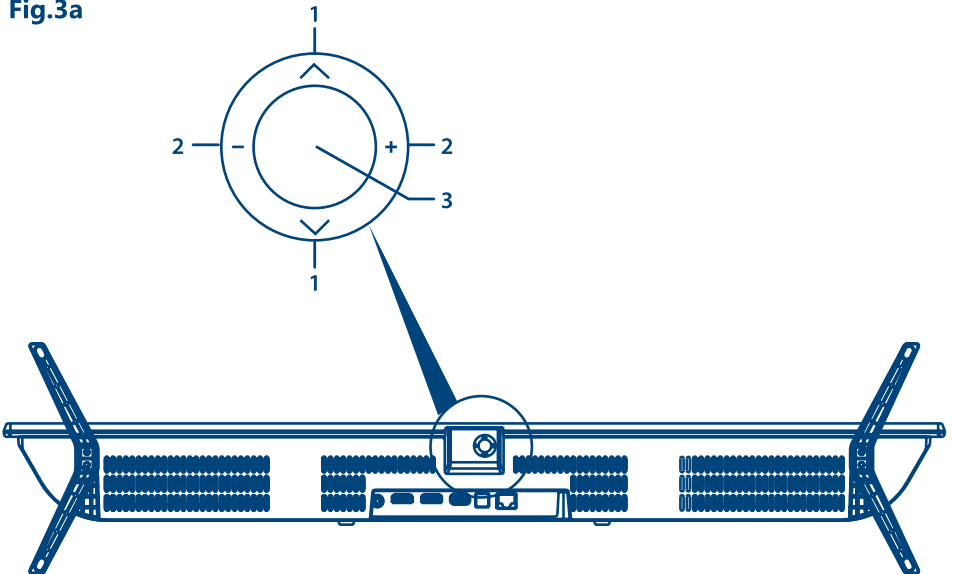

Fig.3b

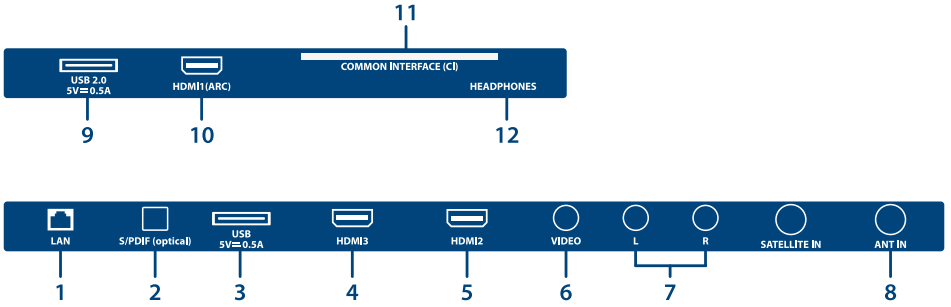

Fig.4

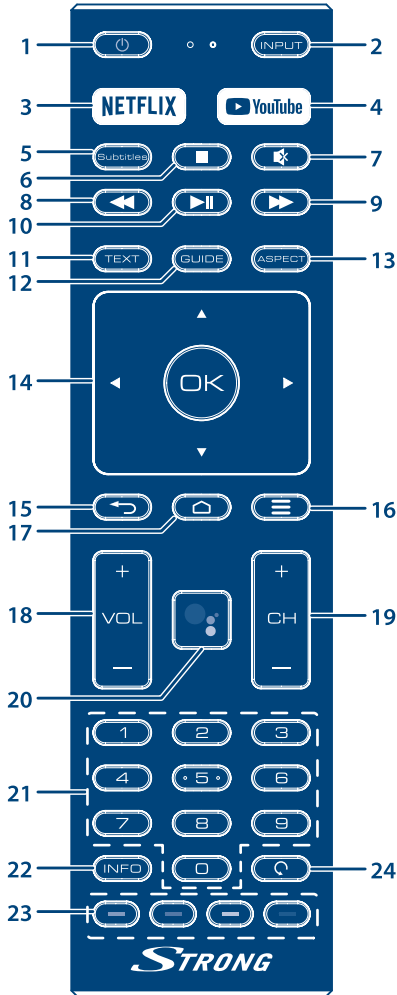
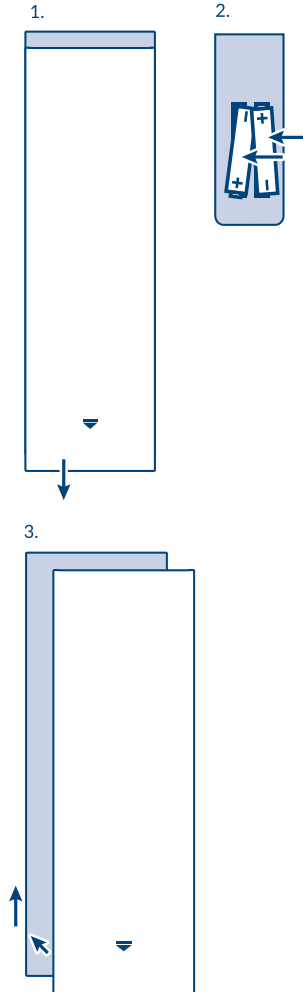

Fig.5



SERVICE CENTER

AT	 support_at@strong.tv  0820 400 150 (€ 0,12/Min. österr. Festnetz)	HU	 support_hu@strong.tv  +36 1 445 26 10
BG	 support_bg@strong.tv  +359 32 634451	IT	 support_it@strong.tv  199 404 032 Da rete fissa 24,8 cent. al min. 12,5 cent. scatto alla risposta Da rete mobile max 49 cent. al min. 15,6 cent. scatto alla risposta
CZ	 support_cz@strong.tv  844 44 44 90	NL	 support_nl@strong.tv
DE	 support_de@strong.tv  0180 501 49 91 (€ 0,14/Min. deutsches Festnetz) (€ 0,42/Min. max. Mobilfunknetze)	PL	 support_pl@strong.tv  801 702 017
DK	 support_dk@strong.tv	PT	 support_pt@strong.tv  +351 2 100 06 125
ES	 support_es@strong.tv  +34 91 119 61 76	SK	 support_sk@strong.tv  0850 15 05 50
FR	 support_fr@strong.tv	SL	 +386 1 828 08 58
HR	 +385 1 344 57 66	UA	 support_ua@strong.tv  +380 (44) 238 61 50

www.strong.tv

Supplied by STRONG Austria
Represented by STRONG Ges.m.b.H.
Teinfalstraße 8/4,Stock
A-1010 Vienna, Austria
Email: support_at@strong.tv

Licenses

THIS PRODUCT IS LICENSED UNDER THE AVC PATENT PORTFOLIO LICENSE FOR THE PERSONAL AND NONCOMMERCIAL USE OF A CONSUMER TO (i) ENCODE VIDEO IN COMPLIANCE WITH THE AVC STANDARD ("AVC VIDEO") AND/OR (ii) DECODE AVC VIDEO THAT WAS ENCODED BY A CONSUMER ENGAGED IN A PERSONAL AND NON-COMMERCIAL ACTIVITY AND/OR WAS OBTAINED FROM A VIDEO PROVIDER LICENSED TO PROVIDE AVC VIDEO. NO LICENSE IS GRANTED OR SHALL BE IMPLIED FOR ANY OTHER USE. ADDITIONAL INFORMATION MAY BE OBTAINED FROM MPEG LA, L.L.C. SEE [HTTP://WWW.MPEGLA.COM](http://www.mpegla.com)

This product contains one or more programs protected under international and U.S. copyright laws as unpublished works. They are confidential and proprietary to **Dolby Laboratories**. Their reproduction or disclosure, in whole or in part, or the production of derivative works therefrom without the express permission of Dolby Laboratories is prohibited. Copyright 2003-2009 by Dolby Laboratories. All rights reserved.

THIS PRODUCT IS SOLD WITH A LIMITED LICENSE AND IS AUTHORIZED TO BE USED ONLY IN CONNECTION WITH HEVC CONTENT THAT MEETS EACH OF THE THREE FOLLOWING QUALIFICATIONS: (1) HEVC CONTENT ONLY FOR PERSONAL USE; (2) HEVC CONTENT THAT IS NOT OFFERED FOR SALE; AND (3) HEVC CONTENT THAT IS CREATED BY THE OWNER OF THE PRODUCT. THIS PRODUCT MAY NOT BE USED IN CONNECTION WITH HEVC ENCODED CONTENT CREATED BY A THIRD PARTY, WHICH THE USER HAS ORDERED OR PURCHASED FROM A THIRD PARTY, UNLESS THE USER IS SEPARATELY GRANTED RIGHTS TO USE THE PRODUCT WITH SUCH CONTENT BY A LICENSED SELLER OF THE CONTENT. YOUR USE OF THIS PRODUCT IN CONNECTION WITH HEVC ENCODED CONTENT IS DEEMED ACCEPTANCE OF THE LIMITED AUTHORITY TO USE AS NOTED ABOVE.

Disclaimer:

Please be aware that STRONG, its manufacturing partners, the application providers and the providers of the services may collect and use technical data and related information, including but not limited to technical information about this device, system and application software and peripherals. STRONG, its manufacturing partners, the application providers and the providers of the services may use such information to improve its products or to provide services or technologies to you, as long as it is in a form that does not personally identify you.

Additionally, please keep in mind that some services provided - already in the device or installed by you - may request a registration for which you have to provide personal data.

Beside that, please be aware that some services which are not pre-installed but can be installed may collect personal data even without providing additional warnings and that STRONG cannot be held liable for a possible breach of data protection by services not pre-installed.

SIMPLIFIED EU DECLARATION OF CONFORMITY

Hereby, STRONG declares that the device SRT 32HC4433 is in compliance with Directive 2014/53/EU.

The full text of the EU declaration of conformity is available at the following internet address: <https://www.strong.tv/en/doc>

Subject to alterations. In consequence of continuous research and development technical specifications, design and appearance of products may change. Manufactured under license from Dolby Laboratories. Dolby and the double-D symbol are registered trademarks of Dolby Laboratories. The terms HDMI and HDMI High-Definition Multimedia Interface, and the HDMI logo are trademarks or registered trademarks of HDMI Licensing Administrator, Inc in the United States and other countries. Wi-Fi is a registered trademark of Wi-Fi Alliance®. Netflix is a registered trademark of Netflix, Inc. YouTube™ is a trademark of Google Inc. All product names are trademarks or registered trademarks of their respective owners.

© STRONG 2021. All rights reserved.

To obtain the best performance and safety, please read this manual carefully. Please keep this manual for future reference.



TABLE OF CONTENTS

1.0 INSTRUCTION	3
1.1 Safety Instructions	3
1.2 Storage	4
1.3 Accessories	4
1.4 Equipment set-up	4
2.0 INSTALLATION	4
2.1 Default PIN code: Access to the LiveTV app to set parental control	4
2.2 Front panel	4
2.3 Rear panel	5
2.4 Remote control	6
2.5 Installing the batteries	6
2.6 Using the remote control	7
3.0 FIRST TIME INSTALLATION	7
4.0 HOME SCREEN	9
4.1 Inputs	10
4.2 Network & internet	10
5.0 LIVE TV USAGE	12
5.1 Channel installation	12
5.2 Watching TV channels	15
5.3 Electronic Program Guide (EPG)	16
5.4 TV Menu	16
6.0 SMART TV POSSIBILITIES	18
7.0 SYSTEM SETTINGS	18
7.1 Settings main menu	19
7.2 Device Preferences menu	19
8.0 MULTIMEDIA	20
8.1 Reminder when using the USB storage devices	20
8.2 Multimedia Player	21
8.2.1 Play videos	23
8.2.2 Browse photos	24
8.2.3 Play music	25
8.2.4 Browse text documents	26
9.0 TROUBLESHOOTING	27
10.0 SPECIFICATIONS	28

1.0 INSTRUCTION

1.1 Safety Instructions

Read all of the instructions before operating the set. Keep these instructions well for later use.

- Only use attachments/accessories specified or provided by the manufacturer (such as the exclusive supply adapter, battery etc.).
- Please refer to the information on the exterior back enclosure for electrical and safety information before installing or operating the apparatus.
- To reduce the risk of fire or electric shock, do not expose this apparatus to rain or moisture.
- The ventilation should not be impeded by covering the ventilation openings with items, such as newspaper, table-cloths, curtains, etc.
- The apparatus shall not be exposed to dripping or splashing and no objects filled with liquids, such as vases, shall be placed on the apparatus.
- The mark  indicates a risk of electric shock. The external wires must be installed by an instructed person or ready-made leads or cords must be used.
- To prevent injury, this apparatus must be securely attached to the floor/wall in accordance with the installation instructions.
- Danger of explosion if the battery is incorrectly replaced. Replace only with the same or equivalent types.
- The battery (battery or batteries or battery pack) shall not be exposed to excessive heat such as sunshine, fire or the like.
- Excessive sound pressure from earphones and headphones can cause hearing loss.
- Listening to music at high volume levels and for extended durations can damage one's hearing.
- In order to reduce the risk of damage to hearing, one should lower the volume to a safe, comfortable level, and reduce the amount of time listening at high levels.
- The mains plug or appliance coupler is used as disconnect device, it shall remain readily operable. When not in use and during movement, please take care of the power cord set, e.g. tie up the power cord set with cable tie or something like that. It shall be free from sharp edges or similar which can cause abrasion of the power cord set. When put into use again, please make sure the power cord is not damaged. In case of damages, please get the power cord replaced by a similar one with the same specifications. The absence of a light indication on the apparatus does not mean that it is fully disconnected from the mains. To disconnect the apparatus completely, the mains plug must be pulled out.
- Attention should be drawn to environmental aspects of battery disposal.
- No naked flame sources, such as lighted candles, should be placed on the apparatus.
-  To prevent the spread of fire, keep candles or other open flames away from this product at all times.
- A USB terminal can provide a maximum of 500 mA.
-  Equipment with this symbol is a Class II or double insulated electrical appliance. It has been designed in such a way that it does not require a safety connection to electrical earth.

Operating Environment

- Do not install this equipment in a confined space such as a bookcase or similar unit.
- Do not use the set near damp, and cold areas, protect the set from overheating.
- Keep away from direct sunlight.
- Do not use the set near dust place.
- Do not attach candle to accessible opening area, to avoid flammable foreign material from entering the TV.

WEEE Directive



Correct Disposal of this product. This marking indicates that this product should not be disposed with other household wastes throughout the EU. To prevent possible harm to the environment or human health from uncontrolled waste disposal, recycle it responsibly to promote the sustainable reuse of material resources. To return your used device, please use the return and collection systems or contact the retailer where the product was purchased. They can take this product for environment-safe recycling.

1.2 Storage

Your device has been carefully checked and packed before shipping. When unpacking it, make sure that all the parts are included and keep the packaging away from children. We recommend that you keep the carton during the warranty period, to keep your device perfectly protected in the event of repair or warranty.

1.3 Accessories

- 1x installation instructions
- 1x Safety Instructions/Warranty Cards
- 1x remote control
- 2x AAA batteries

1.4 Equipment set-up

Fig. 1

Install the display on a solid horizontal surface such as a table or desk. For ventilation, leave a space of at least 10 cm free all around the set. To prevent any fault and unsafe situations, please do not place any objects on top of the set. This apparatus can be used in tropical and/or moderate climates.

This user manual provides complete instructions for installing and using this TV. The symbols serve as follows:

WARNING	Indicates warning information.
NOTE	Indicates any other additional important or helpful information.
MENU	Represents a button on the remote control or the TV. (Bold characters)
<i>Move to</i>	Represents a menu item within a window. (<i>Italic characters</i>)

2.0 INSTALLATION

2.1 Default PIN code: Access to the LiveTV app to set parental control

2.2 Front panel

Fig. 2

NOTE: The graphics are for representation only.

1. Power indicator /remote sensor
2. Speakers

2.3 Rear panel

Fig. 3a

NOTE: The graphics are for representation only.

1. ▲▼ Scans up/down through the channel list. Within the menu system, the buttons operate with equal function of the ▲▼ buttons on the remote and adjust menu controls.
2. ◀▶ Increases/decreases the volume. Within the menu system, the buttons operate with equal function of the ◀▶ buttons on the remote and adjust menu controls.
3. ⏻/Menu Turns the TV on or in standby. If the TV is on, press the button to display *Source Select*. In some menus, press to return to the previous menu. Long press for 3 seconds to display *NAV* menu.

NOTE: The graphics are for representation only.















Fig. 3b

1. **ETHERNET - RJ45** Connect to your Internet router to access the Internet/apps.
2. **S/PDIF (optical)** Use an optical cable to connect your TV to a compatible digital amplifier or Home theatre set.
3. **USB 2.0** USB 2.0 ports.
4. **HDMI 3** Connect HDMI input signal from a signal source such as DVD, Blu-ray player or game console.
5. **HDMI 2** Connect HDMI input signal from a signal source such as DVD, Blu-ray player or game console.
6. **VIDEO** Video IN. Use RCA Male (Plug) to RCA Male (Plug) to connect your TV with home theatre, s-video VCRs, camcorders or DVD players.
7. **AUDIO L/R** Audio Left/Right IN. Use RCA Male (Plug) to RCA Male (Plug) to connect your TV at home theatre.
8. **ANT IN** Connect a coaxial cable to receive signal from the DVB-T2 antenna or DVB-C cable.
9. **USB 2.0** USB 2.0 ports.
10. **HDMI 1 (ARC)** Connect HDMI input signal from a signal source such as DVD, Blu-ray player or game console or directly to a Digital Amplifier that supports the ARC function. This input is equipped with the ARC (Audio Return Channel) feature to implement audio connections and for a full Dolby Audio support.
11. **CI** Insert a Conditional Access Module (CAM).
12. **HEADPHONE** Headphone or Earphone audio output, speakers will be muted when earphone is plugged in and headphone selected.

NOTE: If the TV turns off when you plug a cable to any connector, just turn it on again.

2.4 Remote control

Fig. 4

- | | |
|---|--|
| 1.  | Press to turn the TV on or standby. |
| 2. INPUT | Press to select the different input signal sources |
| 3. NETFLIX | Press for direct access to Netflix* |
| 4. YouTUBE | Press for direct access to YouTube. |
| 5. SUBT | Enable/disable subtitles in DTV mode. |
| 6.  | Press to stop playback. |
| 7.  | Press to mute or restore the volume. |
| 8.  | Press to fast reverse. |
| 9.  | Press to fast forward. |
| 10.  | Press to pause playback, press again to continue playback. |
| 11. TEXT | Press to enter or exit the teletext menu. |
| 12. GUIDE | Press to display the current GUIDE information in DTV mode. |
| 13. ASPECT | Press to change the picture aspect ratio. |
| 14.     OK | Navigate the menu. Confirm the selection. |
| 15. BACK | Press to go back to previously viewed channel. In menu: Back to previous menu. |
| 16.  | Open the menu options. |
| 17.  | Enter the home desktop. |
| 18. VOL +/- | Adjust the volume up or down. |
| 19. CH ▼/▲ | Change programmes up or down. |
| 20.  | Press to activate the voice control function. |
| 21. 0 ~ 9 | Choose channel directly. |
| 22. INFO | Display information about the current source. |
| 23. COLOUR | |
| BUTTONS | Press to execute the prompt function in TV or DTV mode. |
| 24.  | Press to jump to last viewed channel |

* Membership is not included. Netflix is available in selected countries. Streaming Netflix requires to set up an account. Broadband Internet required. See www.netflix.com/TermsOfUse for details.

2.5 Installing the batteries

Fig. 5

Place 2x AAA batteries in the battery compartment of the remote control. Make sure to match the polarity markings inside the compartment.

NOTE: Pictures are for reference only. Actual items may differ.

1. Open the cover.
2. Put 2x AAA batteries in the compartment and make sure the polarity is correct.
3. Close the cover.

Precautions for using the battery

Improper using of the battery will cause leakage. Carefully follow these instructions.

1. Please note the batteries' polarity to avoid short circuit.
2. When the battery's voltage is insufficient which affects the use range, you should replace it with a new battery. Remove the batteries from the remote-control unit if you do not intend to use it for a long time.
3. Do not use different types of batteries (for example Manganese and Alkaline batteries) together.
4. Do not put the battery into fire, and charge or decompose the battery.
5. Please dispose batteries abide by relevant environmental protection regulation.

2.6 Using the remote control

1. Use the remote control by pointing it towards the remote sensor. Items between the remote control and the remote sensor could block normal operation.
2. Do not cause the remote control to vibrate violently. Also, do not splash liquid on the remote control or put the remote control in a high humidity place.
3. Do not place the remote control under direct sunlight which will cause deformation of the unit by heat.
4. When the remote sensor is under direct sunlight or strong lighting, the remote control will not work. If so, please change the lighting or TV's position, or operate the remote control closer to the remote sensor.

* to confirm your choices use **OK** button or right **ARROW** button.

NOTE: This TV is equipped with two remote controls. You can choose to use both remote controls or just one.

3.0 FIRST TIME INSTALLATION

After all connections have been made properly, switch your TV on.

Please follow the initial installation (FTI) procedure on your screen and complete the installation. It will take a few minutes.

TV channels installation

Select your Country and confirm your selection with **OK**.

<p>Country Please select your country: Use 'OK' or 'Right' key to go to next page.</p>	<p>Czechina</p> <p>Denmark</p> <p>Estonia</p> <p>Finland</p> <p>France</p> <p>Germany</p> <p>Greece</p> <p>Hungary</p> <p>India</p>
---	---

Select TV Mode as *Home* or *Retail* to define place of TV installation and usage.

Select TV mode ‘Home’ mode is optimized for efficient energy usage for home use. ‘Retail’ mode is optimized to store demo with fixed settings. Use ‘OK’ or ‘Right’ key to go to next page.	Home Retail
--	----------------

Select your preferred Tuner Mode *Satellite* or *Antenna/Cable*.

Tuner mode Please select your tuner mode: Use ‘OK’ or ‘Right’ key to go to next page.	Satellite Antenna/Cable
--	----------------------------

To install channels for terrestrial or cable broadcasting please select *Antenna/Cable* and choose required type. It is possible to skip scanning and perform it later.

Antenna/Cable Please select your tuner mode: Use ‘OK’ or ‘Right’ key to go to next page.	Antenna Cable Skip
---	--------------------------

To install channels for satellite broadcasting select *Satellite* and perform required settings according to your actual satellite system configuration. It is possible to skip scanning and perform it later. Refer to **Chapter 5.1** for more information for TV channel installation.

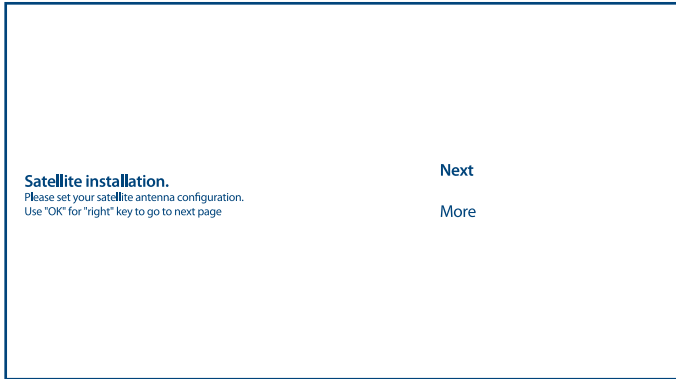

To complete installation follow the instruction on the screen.

Congratulations! You have successfully completed the First time installation of your TV.

4.0 HOME SCREEN

The Home screen is the main screen of this model of TV.

It divided on few zones and lines and contains

- Search line with possibility to enter text to search information or content, related with this text;
- Notification corner, which provide information about system notifications and messages. It also gives quick access to TV inputs, connections, settings and show current system time.
- Application line *Apps*, which contain the list of most used applications, including *Live TV* application and others, and icon *Apps* – for access to complete applications list, installed in the system, and to Application Store to get to other new applications;
- Few more lines, which also called *Channels*, which shows detailed content, specific for each application. It is possible to customize this area. Use *Customize channels* to make changes.

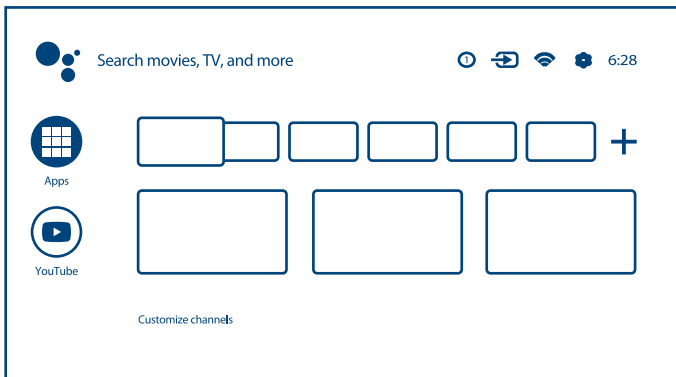

To access Home screen and exit from any active application, press **Home** button on the remote control unit (RCU).

Use **Left/Right** and **Up/Down** to move around and **OK** to enter the option or application.

4.1 Inputs

TV has such possible inputs or sources: *TV or Channels, Composite, HDMI 1, HDMI 2 and HDMI 3.*

To access to this option, select *Inputs* item on Home screen or press **INPUT** button on RCU.

Select the input sources of the devices which are connected to the TV through the different inputs or ports.

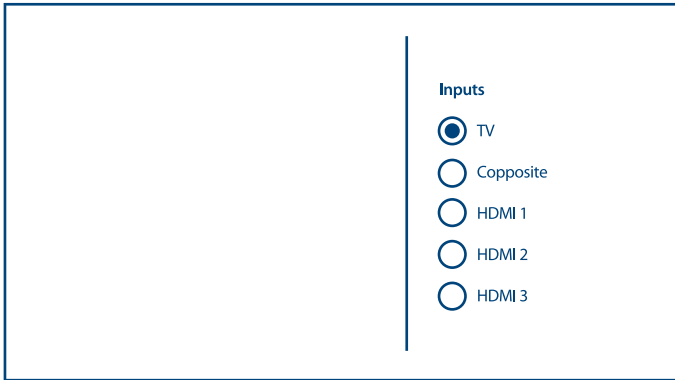

4.2 Network & internet

Connection to internet allows to install and use internet applications (i.e. Youtube, Netflix, etc.) and to enjoy of other advantages of Smart TV.

Access to the part for network and internet connection is through chapter *Network & internet* of *Settings* menu or through quick access panel on Home screen.

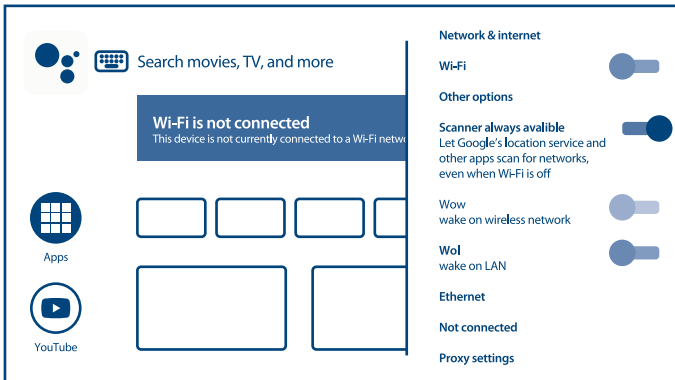

Your TV can be connected to your home network in two ways:

- Wired, using the RJ-45 (LAN) connector on the back panel.

- Wireless, using the internal wireless and your home wireless network.

NOTE:

To access the Internet, you must subscribe to a highspeed broadband Internet service with your Internet service provider.

NOTE:

Instructions below are just the usual ways to connect your TV to a wired or wireless network. The connection method may differ depending on your actual network configuration. If you have any questions about your home network, please refer to your Internet service provider.

Connecting to a wired network

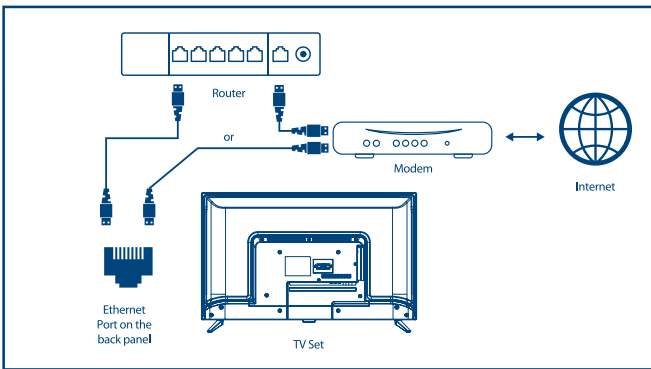

To connect to a wired network

1. Ensure you have:
 - An Ethernet cable long enough to reach your TV
 - A router or modem with an available Ethernet port
 - A highspeed Internet connection
2. Connect your Ethernet cable to the router and to the Ethernet port on the back of the TV.
3. Use *Ethernet* part of menu to configure the connection (if required).

Connecting to a wireless network

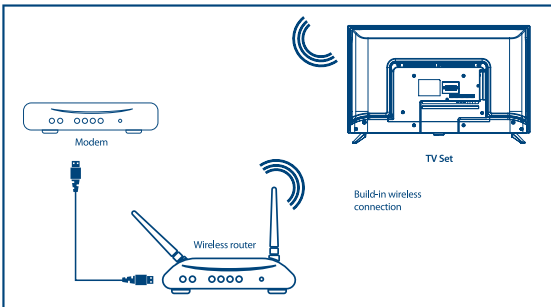

To connect to a wireless network:

1. Ensure you have:
 - A router broadcasting a 2.4GHz wireless signal
 - A highspeed Internet connection
2. Select your Wi-Fi network from the *Available networks* list and enter password for connection.
3. Use other options of menu to configure the connection (if required).

Please refer to **chapter 6** to read more about Smart features of your TV.

5.0 LIVE TV USAGE

Select *Live TV* application from Home screen or *TV or Channels* from input menu to watch live TV channels. Press **OK** to start this application.

This application gives you access to live TV to watch and enjoy your favorite TV and radio programs from TV sources (Aerial/Antenna, Cable or several of Satellites) of your choice.

In case if you skipped DTV installation during FTI and enter application for the first time, application will recommend to perform channel scanning and installation.

NOTE:

Please note, that nothing to watch, if no channels were scanned and installed.

5.1 Channel installation

Exist two ways to install channels.

Way 1 - through TV menu from *Channels* chapter

This is simple procedure to add channels.

Press **MENU** and then **▲** button to get to *Channels* chapter.

Select **CH+** icon to add new channels.

Select source for channels installation.

Select *Tuner(DTV)* for digital channels installation. Other options are *Tuner(ATV)* - for analog or cable channels installation and *Google Play Movies & TV* – for streaming TV channels from internet.

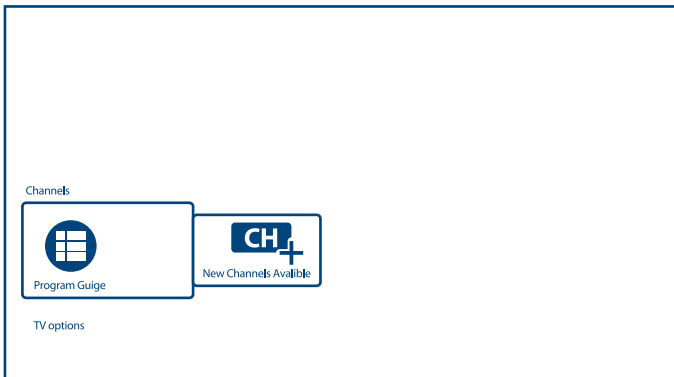

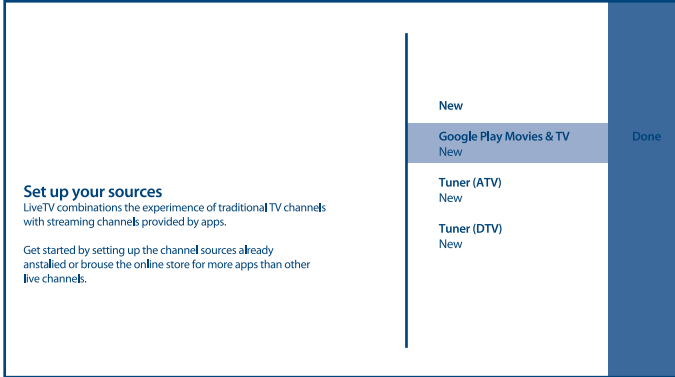

For *Tuner(DTV)* source will start same procedure of channel installation, as for FTI. Select Tuner Mode as *Satellite* or *Antenna/Cable* and follow instructions on screen. For more details please refer to **Chapter 3**.

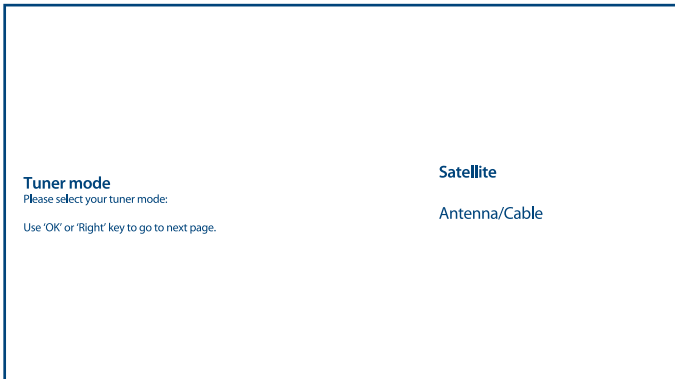

For *Tuner(ATV)* source system start scanning for analog or cable TV channels from connected antenna. It is possible to skip scanning - just select *Skip Scan* item. No other settings available.

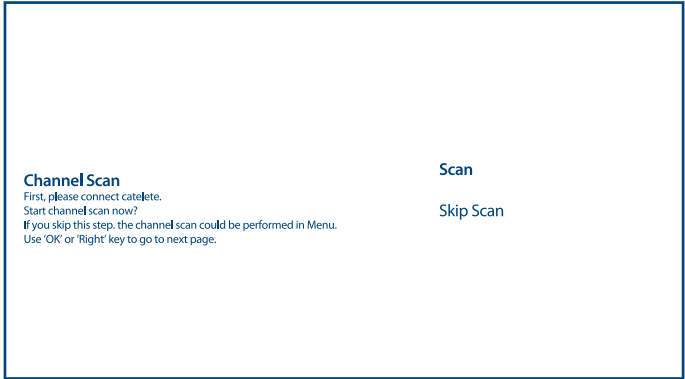

After installation of new channels completed, confirm finish of it with *FINISH* item.

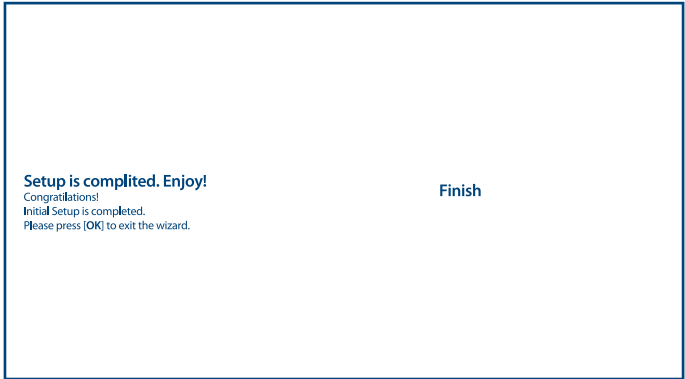

Select *Done* on source screen to exit from procedure.

Way 2 - through Settings menu from *Channel* chapter

This is more universal procedure to add channels. Here also possible to define more options for channels.

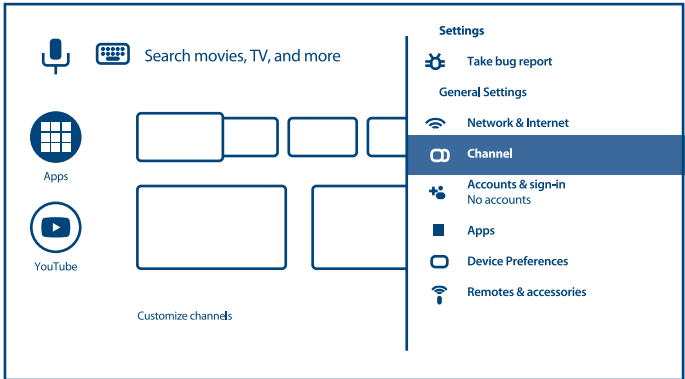

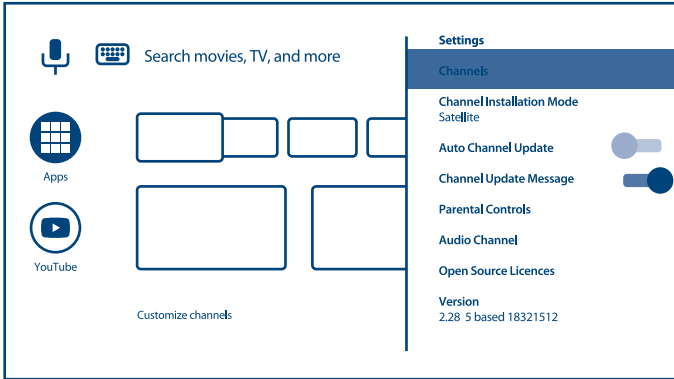

Channels

This chapter is for channel installation (add/update or re-scan satellite, for manual tuning of channels) and channel management (skip, sort, move or edit channel in list or clear channel list).

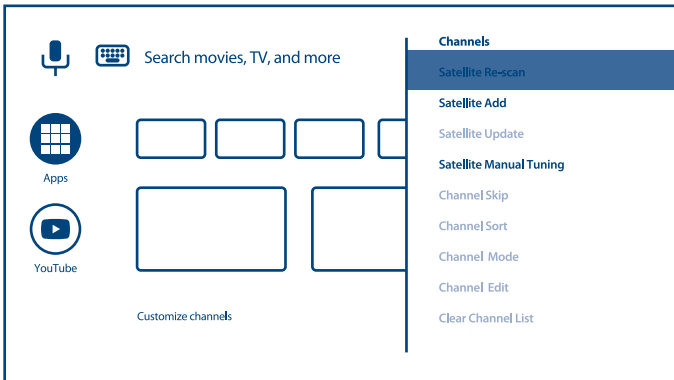

Channel Installation Mode

This chapter is for selecting source for channel installation and performed.

Available options are *Antenna, Cable or Satellite*.

Other options and items in *Channel* chapter:

Auto Channel Update - to update channel list automatically in case, if operator change it;

Channel Update Message - to show message about channel update;

Parental Controls - (available after password entered correctly) to define Blocked channels, Program Restrictions, to block/unblock inputs and to change password/PIN;

Audio Language and 2nd Audio Language

- to define preferable and 2nd audio language, if this available from broadcasting.

5.2 Watching TV channels

When the installation is completed, you can use TV set for watching of installed TV programs.

Some helpful features for comfortable watching.

Changing channels

Following ways are possible for changing channels:

- Via direct access using the **0~9** buttons.
- Via the **▲▼** or **CH+/CH-** buttons.
- Via the channel list using **OK** and **▲▼** buttons. Use **COLOUR** buttons in the list to move through list Page Up or Down, select more options to form the list (by type, sort or to find channel by number or by name) or to switch to Favorites List.

Info Banner

While watching TV you can press **INFO** button to get information about current and next program and event on broadcasting*.

Press **INFO** twice or more to switch on/off more details of currently broadcasted program.

* Event information is displayed when available. Availability depends on the broadcast.

5.3 Electronic Program Guide (EPG)

EPG stands for Digital Electronic Program Guide. It is supplied by the programme providers and offers information on broadcasted programmes. You can access it in digital mode by pressing **GUIDE** on the remote control. Press **GUIDE** to bring up the EPG interface. Use **▲▼** to select channel and **◀▶** to see detailed information for program

Press **BACK** to stop and return to viewing modes.

Press **COLOUR** buttons to make required actions.

RED	jump to Previous Day of EPG
GREEN	jump to Next Day of EPG
YELLOW	scroll detailed information about program
BLUE	define filter (i.e. by genre) for EPG information

5.4 TV Menu

You can use the menu of *Live TV* application to make changes in channels viewing and set other options.

Press **≡** to open the menu of TV application.

It has 2 levels *TV options* (default) and *Channels*.

TV options consists of submenus: *Source, Picture Mode, Display Mode, Sound Mode, Speakers, Power, CI Card, Advanced Options* and *Settings*.

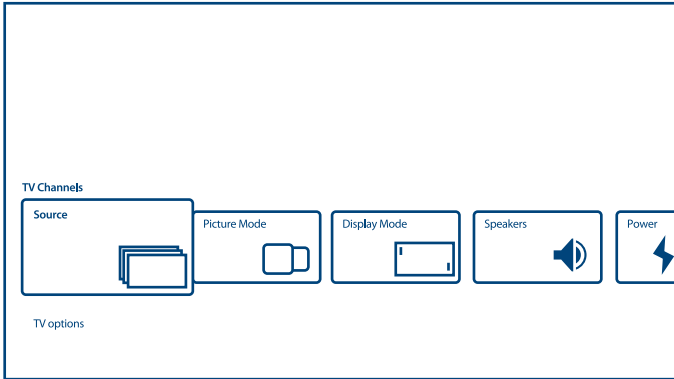

Source will call same menu of Inputs, as described above. Refer to **Chapter 4.1** for more information.

Picture Mode propose such options for moving pictures quality: *Standard* (as default) and *User, Vivid, Sport, Movie, Game, Energy Saving*. Select for most acceptable for you picture quality.

Display Mode propose such options for Display aspect ratio: *Automatic* (as default) and *Full, Super Zoom, Unscaled, 4:3, Movie expand 14:9, Movie expand 16:9*.

This sub-menu also available by pressing of **ASPECT** button on RCU.

Speakers propose such options for TV sound outputs: *TV Speakers* (as default) and *External Audio System*.

Power will define such parameters as *Sleep Timer, Switch Off Timer, No Signal Auto Power Off* and other.

CI Card call CI slot and CAM card menu, as: *CAM Menu, CAM scan, User Preference*. Could contain other items, depending of used CAM card.

Advanced Options define additional options and information about broadcasting.

Available options and parameters:

Sound Tracks – to select sound track, if available from broadcast;

Default Channel – to select channel as default after TV switch on;

HBBTV Settings – to define parameters of HBB TV support and usage;

Auto Sleep – to define period of user's inactivity to switch TV to standby mode;

some other parameters for Subtitle, Teletext and other.

And also

System Information – to show detailed information about current channel, like Signal Level and Quality, Frequency, Service ID, etc.

Version Info – Model name and FW version

2nd TV menu level

This level called *Channels* and gives access to some information and parameters of broadcasting.

To enter this menu press **≡** then **▲** button.

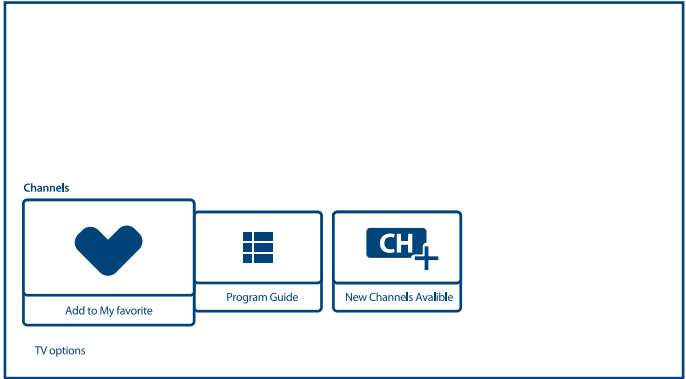

It contains such items: *Add to My Favorites*, *Program Guide*, *CH+ (New Channels Available)*.

Add to My Favorites allows to add or remove current channel to/from Favorite channel list. Heart in RED color meaning, that selected channel included into Favorite channel list.

Program Guide gives access to EPG. Please refer to **Chapter 5.3** for more information how to use it.

CH+ (New Channels Available) tool allows quickly add/install new channel to channel list. Please refer to **Chapter 5.1** for more information how to use it.

6.0 SMART TV POSSIBILITIES

Your TV model is smart. That's meaning that in addition to watching of normal Live TV, it provided some extra features, which allows you to use it in more flexible and wide way, to select other video content sources, like YouTube, Netflix, etc., to install various applications to extend functionality of your TV.

NOTE:

Using of smart functionality of your TV require connection to internet and, in most cases, using your Google account. Please refer to **Chapter 3** and **Chapter 7** for information how to setup internet connection and enter to Google account.

Using Google account give you access to applications and games, movie and music market of Google Play Store. Here you could search, select and install some useful utilities or games, applications for IPTV content, for watching streaming video and music content, another player for multimedia, receive actual weather information and other.

Quite often application required registration and using of unique account to get access to their services. Please note, that not all services are for free and require subscription fee. Please keep this information in private.

7.0 SYSTEM SETTINGS

Access to all settings of your TV provided from chapter *Settings* menu through quick access panel on Home screen or from menu of *Live TV* application.

7.1 Settings main menu

Main features, like network connection, channel installation, accounts and other, are available from first screen of setting menu.

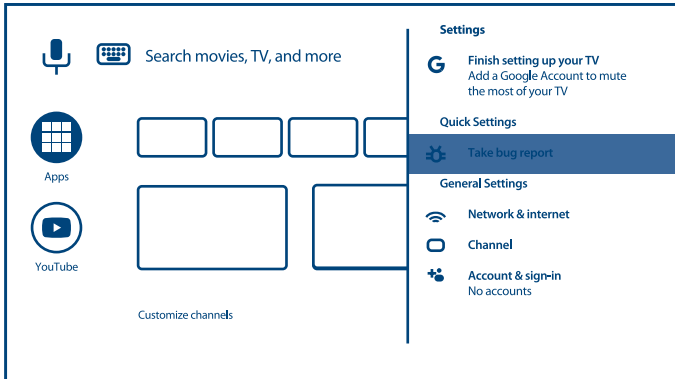

Here you will get some system suggestions, manage your accounts (*Accounts & sign-in*), your applications (*Apps*), defining parameters for permissions, special access and Security & restrictions options.

For *Network & internet* connections please refer to **Chapter 4.2**

Chapter *Channel* is for *Live TV* channel installation and management. Please refer to **Chapter 5.1** for more information.

In chapter *Remotes & accessories* you could add to TV and manage accessories, like remote control unit, Bluetooth headphones, etc.

7.2 Device Preferences menu

To get access to all device control options, like *Date & time*, *Language*, *Picture*, *Sound*, etc., please select *Device Preferences* chapter on this menu.

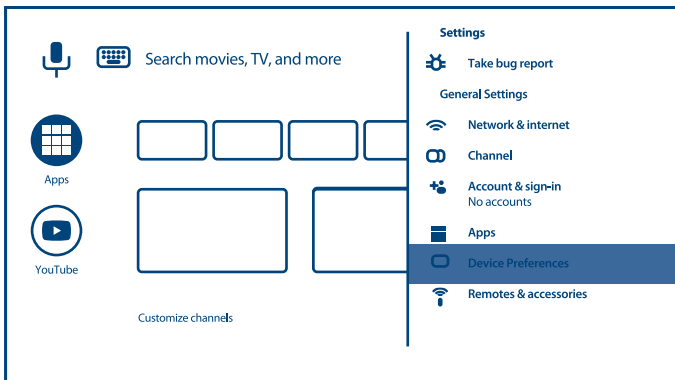

Press **MENU** to display the main menu. Press **▲/▼** to select *Device Preferences* in the main menu, then press **OK** to enter the sub-menu.

Sub-menu content:

<i>About</i>	provide information about your device model and name, some other useful information and also give access to tool of restart or update system
<i>Date & Time</i>	define the way how to set local date and time, set format of this information, select local time zone.
<i>Timer</i>	set Power On/OFF time parameters for the TV.
<i>Language</i>	display various languages list to set menu language for you TV. Use ▲/▼ to select required language and press OK to confirm.
<i>Keyboard</i>	set graphical on-screen keyboard parameters.
<i>Inputs</i>	select and manage available in TV inputs.
<i>Power</i>	define power consumption parameters, like <i>Sleep Timer</i> , <i>Picture off</i> , <i>Switch Off Timer</i> and <i>No Signal Auto Power Off</i> .
<i>Picture</i>	define picture mode and manually set picture parameters like Brightness, Contrast, Saturation, Colour, Temperature, etc.
<i>Sound</i>	define system sound mode and manually set sound parameters like System sounds, Balance, Equalizer, Auto Volume Control, etc.
<i>Storage</i>	information about internal and connected storage devices
<i>Home screen</i>	customize appearance of your Home screen.
Other options available in this menu: <i>Retail Mode</i> , <i>Google Assistant</i> , <i>Chromecast built-in</i> , <i>Screen saver</i> , <i>Location</i> , <i>Usage & diagnostics</i> , <i>Accessibility</i>	
<i>Reset</i>	Return all parameters of your TV to factory settings. Please note when confirming this choice, all previously manually defined settings, all installed applications and entered accounts will be deleted and your TV will be reset to the factory settings!

8.0 MULTIMEDIA

8.1 Reminder when using the USB storage devices

1. Some USB storage devices may not be compatible to operate smoothly with this TV.
2. Back up all of the data in the USB storage device in case data is lost due to an unexpected accident. STRONG does not assume any liability for the losses by misuse or malfunction. Data backup is consumer's responsibility.
3. For large file sizes, the loading speed may be slightly longer.
4. The recognition speed of a USB storage device may depend on each device.
5. When connecting or disconnecting the USB storage device, make sure the TV is not in USB mode, otherwise the USB storage device or the files stored in it may be damaged.
6. Please use only a USB storage device which is formatted in FAT16, FAT32, NTFS (playback only) file system provided with the Windows operating system. In case of a storage device formatted as a different utility programme which is not supported by Windows, it may not be recognized.
7. When using a USB Hard Disk Drive, which is not powered independently, ensure its power does not exceed 500 mA. Otherwise, the TV system will change into standby mode, and you must pull out the USB Hard Disk and restart the TV system.
8. An "Unsupported File" message will be displayed if the file format is unsupported or the file is corrupted.
9. FHD big picture needs longer time to process, which is not caused by the TV. Please be patient.

10. This TV may not support some multimedia files changed and upgraded as the change of the encoding format or other technical aspects advances.

8.2 Multimedia Player

To playback media files like to view videos and movies, play music, show photos and pictures and read text files from your USB storage devices recommended to use built-in Multimedia Player (also shown on icon like MMP). It available from the list of installed applications.

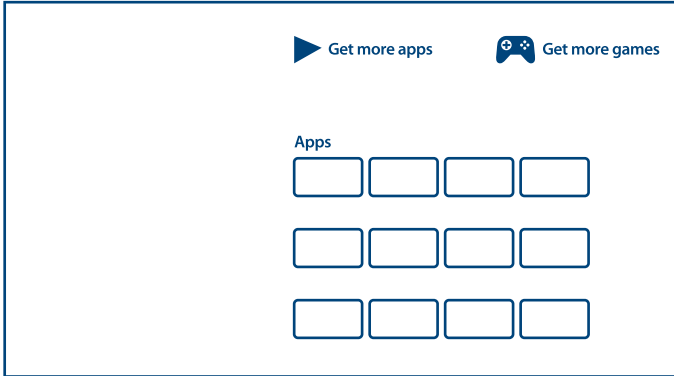

With Multimedia Player you can reproduce video, audio, picture or text files of supported formats from your USB storage devices on your TV screen.

NOTE: If, for any reason, you do not like to use built-in Multimedia Player application, you could enter to Google Play Store and install any of available media players (i.e. MX Player, VLC Player, etc.).

NOTE: Support (or non-support) of multimedia files depend not only on your TV, but also on application, which will be used for playback. Different multimedia applications could contain built-in abilities to support various formats and types of multimedia files.

Connect a USB storage device to the USB port, run Multimedia Player and select the types of media on the Multimedia selection page: *Video, Photo, Audio* and *Text*.

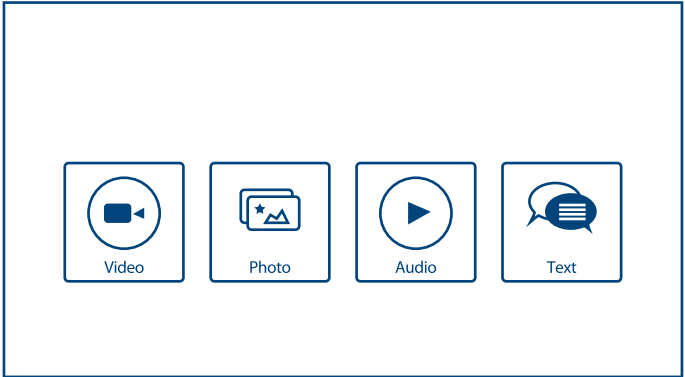

Press **OK** to confirm selection

The screen will show:

- On the left part of the screen: type of selected media and brief information about selected file. If file paused or continue playing in small screen, it will also be shown here.
- On the right part of the screen: the content of connected USB device, with folders and files.

Use ▲▼ and ◀▶ to select folder or file.

Press **OK** to open the folder.

Highlight the file you want to play or watch and press **OK** to open it.

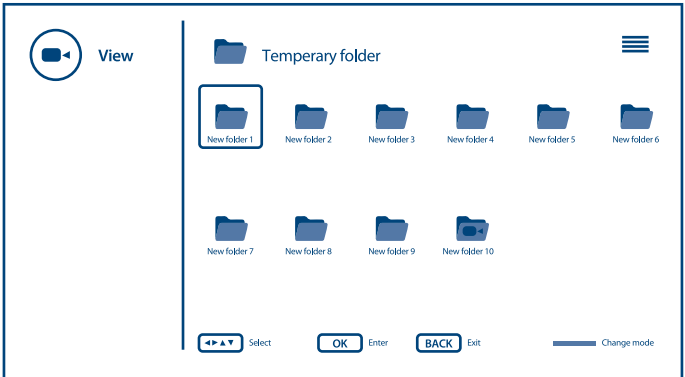

It is possible to change view folder structure from icon to tree mode and back by **BLUE** button.

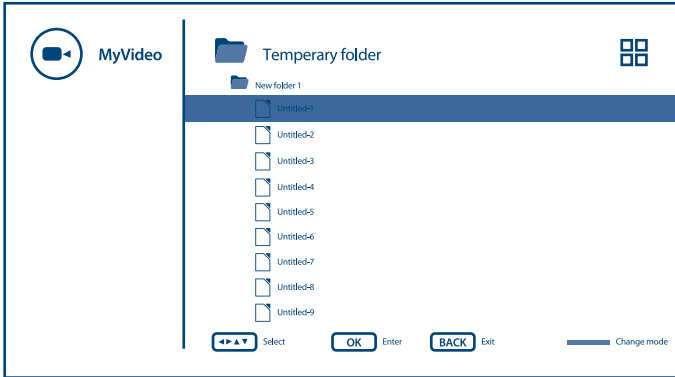

During playback you could use multimedia buttons on your RCU or use on-screen commands, available from menu by **≡** button.

NOTE: By choosing one of the media types, for example *Video*, the folders inside will display only compatible media files and no other files of other types.

8.2.1 Play videos

Select icon *Video* from Multimedia type selection page and select file for playback.

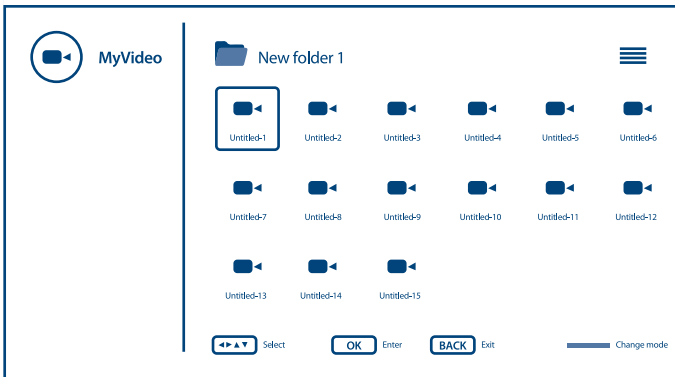

To get access to control playback during playback press **≡** to display/exit the menu.

Available options:

- Play/Pause* to play or pause the playback
- Repeat* select repeat mode for playback
- Show info* display detailed information about file
- Picture Settings* call system menu for picture adjustment
- Sound Settings* call system menu for sound settings

Sound Tracks select sound tracks (if available)
Last Memory to switch off or remember the timestamp for continue if playback of this file was stopped but was not run to an end

Jump Time enter the timestamp, from which playback should be continued

RCU multimedia buttons usage:

- ▶ || to play or pause the playback
- to stop playing
- ◀▶ press and hold for seconds to draw the playing progress as your desire, then press ▶|| to pause or continue playing from new position.
- INFO display detailed information about file

8.2.2 Browse photos

Select icon *Photo* from Multimedia type selection page and select file from which will start slideshow playback.

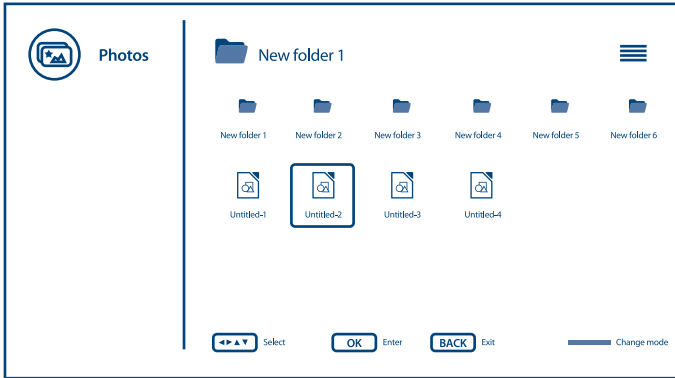

To get access to control playback during playback press ≡ to display/exit the menu.

Available options:

- Play/Pause* to play or pause the slideshow playback
- Repeat* select repeat mode for slideshow playback
- Shuffle* on/off shuffle for slideshow playback
- Rotate/Duration* to rotate picture on screen and to define how long picture will stay on screen during slideshow playback
- Zoom/Effect* to zoom in picture on screen and to define effect for picture changing during slideshow playback
- Show info* display detailed information about file
- Photo Frame Image* to mark picture as Frame image

RCU multimedia buttons usage:

- ▶ || to play or pause the slideshow playback
- to stop show/playback
- ◀▶ (not used)

INFO display detailed information about file

8.2.3 Play music

Select icon *Audio* from Multimedia type selection page and select file for playback.

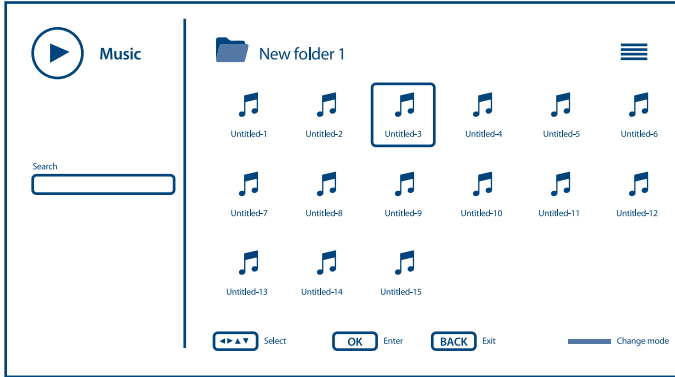

To get access to control playback during playback press to display/exit the menu.

Available options:

- Play/Pause* to play or pause the playback
- Repeat* select repeat mode for playback
- Shuffle* on/off shuffle for playback
- Show info* display detailed information about file
- Hide Spectrum* switch off animation of playback (if available)
- Lyric Options* define some lyric options (if available)
- Picture Off* call system menu for power saving adjustment
- Sound Settings* call system menu for sound settings

RCU multimedia buttons usage:

- to play or pause the playback
- to stop playing and goto the very beginning of the track
- press and hold for seconds to draw the playing progress as your desire, press to pause or continue playing from new position.

INFO display detailed information about file

NOTE:

- This menu only shows supported files.
- Files with other file extensions are not displayed, even if they are saved on the same USB storage device.
- An over-modulated mp3 file may cause some sound distortion during playback.
- This TV supports lyrics display (in English). The maximum number of characters per line is 48.
- The file name of music and lyrics must be the same in order to display lyrics while the music is playing.
- If you want to show the associated lyrics on the screen with the music, you must store these in the same folder using the same file name with ".lrc" file extensions.

8.2.4 Browse text documents

Select icon *Text* from Multimedia type selection page and select file for playback.

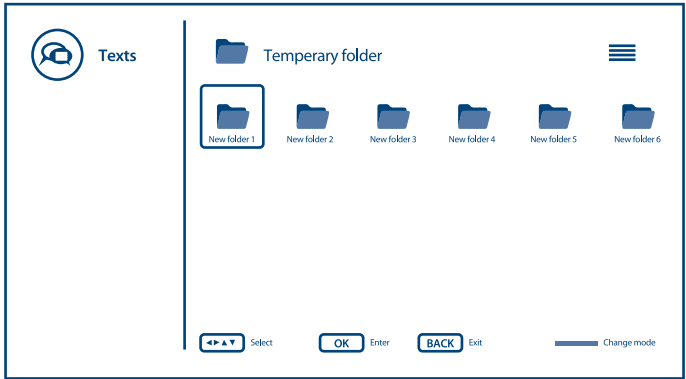

To get access to control playback during playback press to display/exit the menu.

Available options:

- Play/Pause* to play or pause the text scroll
- Repeat* select repeat mode for text playback
- Shuffle* on/off shuffle for text playback
- Font* to define such parameters of text Size, Style and Color
- Show info* display detailed information about file

RCU multimedia buttons usage:

- to play or pause the text scroll
- to stop show/playback
- (not used)
- INFO** display detailed information about file

9.0 TROUBLESHOOTING

Before calling a service technician, review following information for possible causes and solutions for the problem you are experiencing. If the TV does not work properly after checking it, please contact your local service line or STRONG dealer. Alternatively, you can send a support mail via our website www.strong.tv.

Problem	Possible cause and solution
No picture, no sound	<ol style="list-style-type: none"> 1. Check if the fuse or circuit breaker is working. 2. Plug another electrical device into the outlet to make sure it is working or turned on. 3. The power plug is in bad contact with the outlet. 4. Check the signal source.
No colour	<ol style="list-style-type: none"> 1. Change the colour system. 2. Adjust the saturation. 3. Try another channel. Black-white programme may be received.
The remote control does not work	<ol style="list-style-type: none"> 1. Change the batteries. 2. The batteries are not installed correctly. 3. Main power is not connected.
No picture, normal sound	<ol style="list-style-type: none"> 1. Adjust the brightness and contrast. 2. Broadcasting failure may happen.
Normal picture, no sound	<ol style="list-style-type: none"> 1. Press the volume up button to increase the volume. 2. The volume is set to mute, press  to restore the sound. 3. Change the sound system. 4. Broadcasting failure may happen.
Unorderly ripples on the picture	It is usually caused by local interference, such as cars, daylight lamps and hair driers. Adjust the antenna to minimize the interference.
Snowy dots, blocking and interference	<p>If the antenna is located in the fringe area of a television signal where the signal is weak, the picture may be marred by dots, show blocking or break-ups. When the signal is extremely weak, it may be necessary to install a special antenna to improve the reception.</p> <ol style="list-style-type: none"> 1. Adjust the position and orientation of the indoor/outdoor antenna. 2. Check the connection of the antenna. 3. Fine tune the channel. 4. Try another channel. Broadcasting failure may happen.
Ghost	Ghosts are caused by the television signal following two paths. One is the direct path, the other is reflected from tall buildings, hills, or other objects. Changing the direction or position of the antenna may improve the reception.
Radio frequency interference	This interference produces moving ripples or diagonal streaks, and in some case, loss of contrast in the picture. Find out and remove the radio interference source.
Playback of video is causing picture freeze/ macro blocks or similar distortion, especially on HD content	Read/write speed of your USB device could be too low. Make sure to use a USB storage device with sufficient speed and space. Pen drives (USB sticks) may not support sufficient speed.

Problem	Possible cause and solution
No signal or weak signal, intermittent reception	<p>a) Cables might have loosened; moisture might have entered into cables or connectors, heavy rain at present or heavy storm at present. Check the cable connections, LNB and other equipment connected between the LNB and the receiver, or peak the dish. Wait for rain/storm to subside. Ask a local satellite specialist for advice.</p> <p>b) The satellite dish is not pointing at the (correct) satellite(s). Adjust the dish. Ask a local satellite specialist for advice.</p> <p>c) Satellite dish is too small, trees or buildings in path. Change to a larger dish or change position of dish.</p> <p>d) Signal is too strong, dish is oversized. Connect a signal attenuator to the LNB input. Ask a local satellite specialist for advice.</p>
Bad picture/blocking error during heavy rain	<p>Heavy rain will attenuate satellite signals, below a certain level blocking will occur. Make sure your dish installation is up to standards to minimize rain effects. When in doubt, ask a local satellite specialist for advice.</p>
If the TV turns off after plugging a cable into any connector	Again, turn on the TV.

NOTE:

If the problem persists after these solutions, please contact your local support centre or send a support mail via our website www.strong.tv.

10.0 SPECIFICATIONS

Audio

Audio Output: 2 x 8 W

Video

Channel coverage: DVB-T2: 174 MHz-230 MHz; 470 MHz-860 MHz
DVB-C: 113-858 MHz
DVB-S2: 950 MHz-2150 MHz

System: DTV: DVB-T2, DVB-S2, DVB-C
ATV: PAL/SECAM (BG/DK/1)
AV: PAL, NTSC, SECAM

Connectors 32"

1x ANT IN
1x CI
3x HDMI
2x USB 2.0
1x LAN (RJ-45)
1x S/PDIF (optical)
1x HEADPHONE
1x RF

1x VIDEO
1x AUDIO

General Data

Operating voltage:	100 V ~ 240 V AC 50/60 Hz
Power consumption:	max. 48 W, typ. 39 W
Power consumption in standby:	≤ 0.5 W
Operating temperature:	-2 °C ~ +35 °C
Storage temperature:	-20 °C ~ +60 °C
Operating humidity:	25% ~ 70% RH, non-condensing
Storage humidity:	25% ~ 50% RH, non-condensing
Dimensions (WxDxH) in mm:	730 x 179.7 x 467.4 730 x 61 x 427 (with stand)
Net-weight:	3.6 kg 3.5 kg (with stand)

Data Protection:

Please be aware that STRONG, its manufacturing partners, the application providers and the providers of the services may collect and use technical data and related information, including but not limited to technical information about this device, system and application software and peripherals. STRONG, its manufacturing partners, the application providers and the providers of the services may use such information to improve its products or to provide services or technologies to you, as long as it is in a form that does not personally identify you.

Additionally, please keep in mind that some services provided - already in the device or installed by you - may request a registration for which you have to provide personal data.

Besides that, please be aware that some services which are not pre-installed but can be installed may collect personal data even without providing additional warnings and that STRONG cannot be held liable for a possible breach of data protection by services not pre-installed.