

STRONG

HD SMART Google TV with DVB-T2/C/S2
SRT 32HG6733C



User manual
Manuel d'utilisation
Manual de usuario
Benutzerhandbuch
Manuale di istruzioni
Manual de instruções
Ръководство за употреба
Νάvod k použití
εγχειρίδιο οδηγιών

Priručnik
Használati útmutató
Handleiding
Instrukcja obsługi
Manual de instrucțiuni
Návod na použitie
Інструкція з експлуатації
Упутство за коришћење
Navodila za uporabo

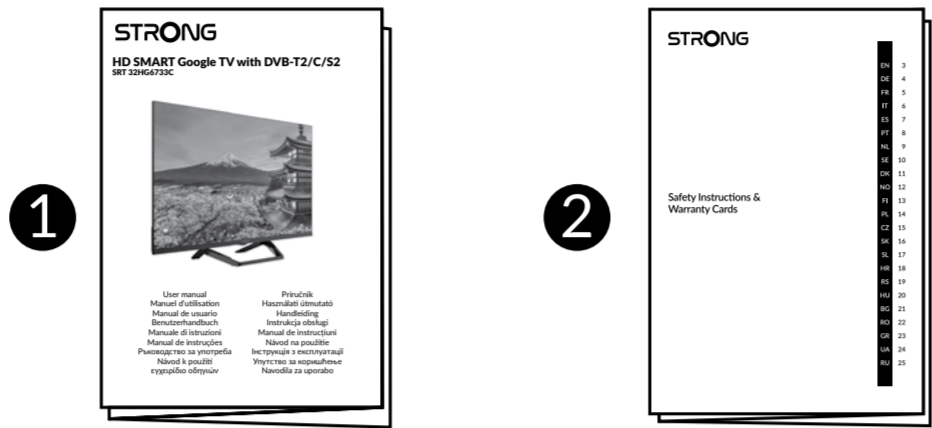

Manual: www.strong-eu.com

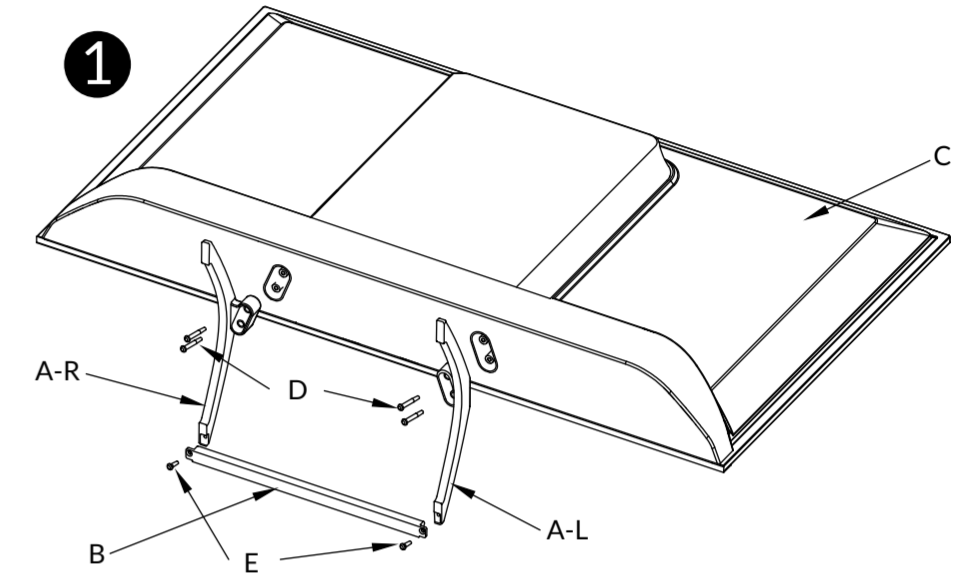
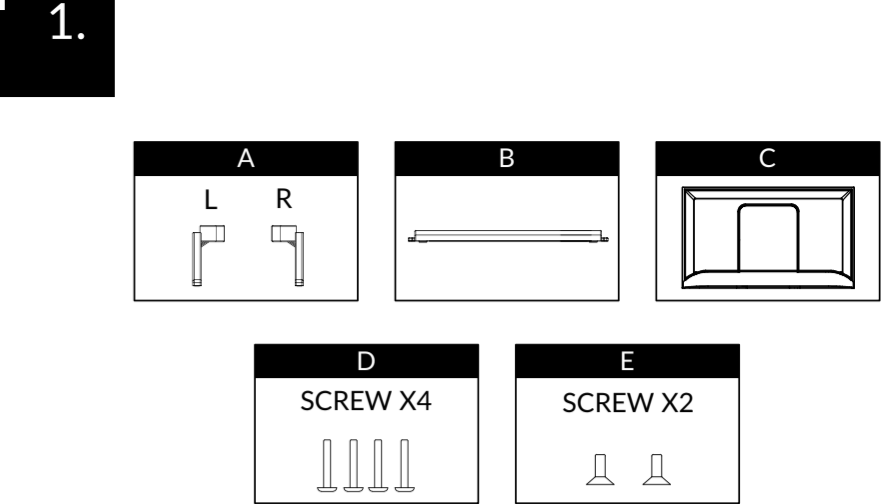
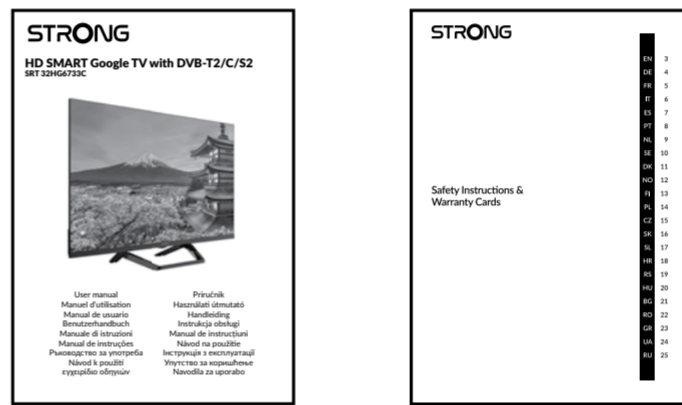
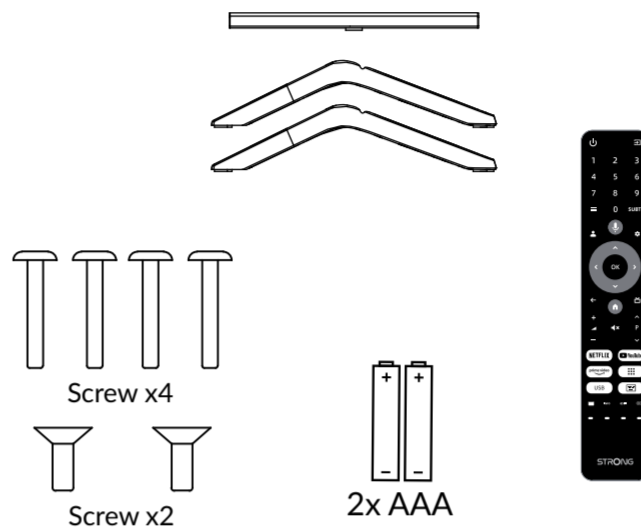
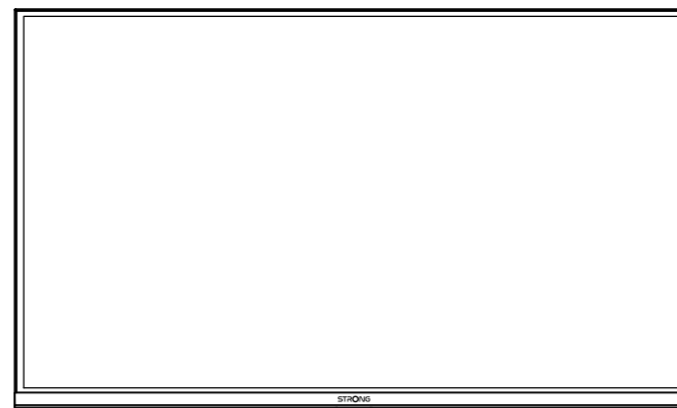

SERVICE CENTER			
AT	support_at@strong-eu.com 0820 400 150 (€ 0,12/Min, Österr. Festnetz)	HU	support_hu@strong-eu.com +36 1 445 26 10
BG	support_bg@strong-eu.com +359 32 634451	IT	support_it@strong-eu.com
CZ	support_cz@strong-eu.com 844 44 44 90	NL	support_nl@strong-eu.com
DE	support_de@strong-eu.com 0800 7788 787 (Gebührenfrei)	PL	support_pl@strong-eu.com 801 702 017
DK	support_dk@strong-eu.com	PT	support_pt@strong-eu.com +351 2 100 06 125
ES	support_es@strong-eu.com +34 91 119 61 76	SK	support_sk@strong-eu.com 0850 15 05 50
FR	support_fr@strong-eu.com	SL	+386 1 828 08 58
HR	+385 1 344 57 66	UA	support_ua@strong-eu.com +380 (44) 238 61 50



Supplied by STRONG AUSTRIA
Represented by STRONG Ges.m.b.H.
Teinfaltstraße 8/4, Stock,
A-1010 Vienna, Austria
Email: support_at@strong-eu.com

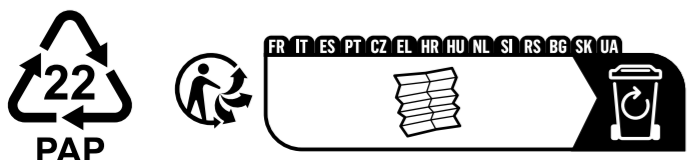

22 May 2024 13:36



Optionnal Wall-mount

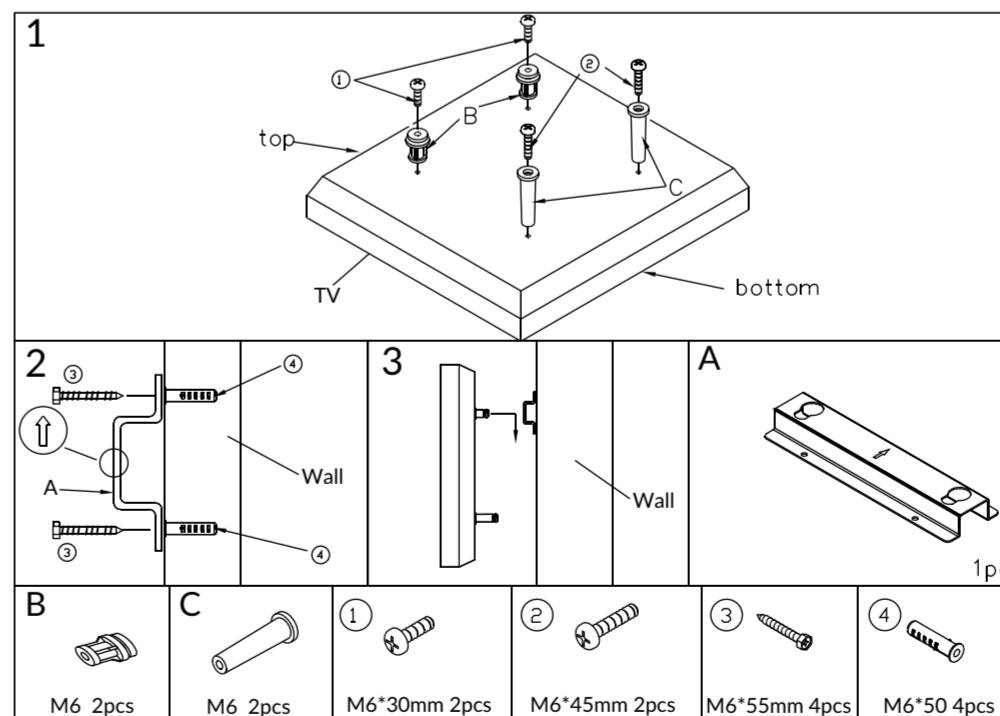

*Wall-mount and screws not included in the packaging

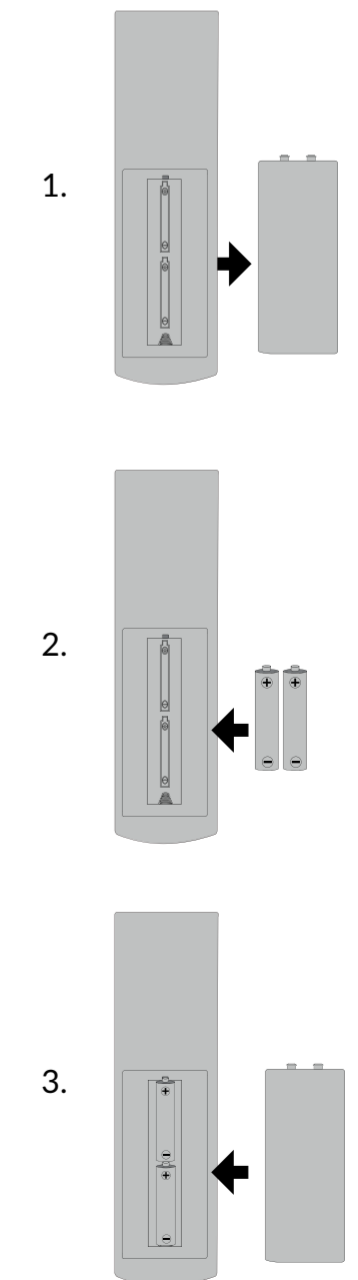
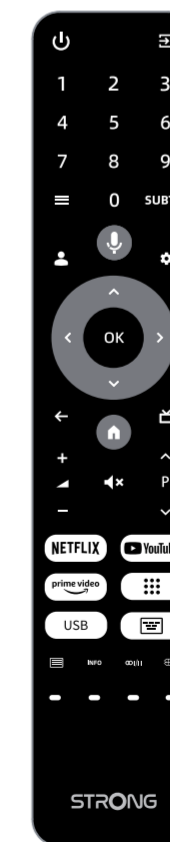

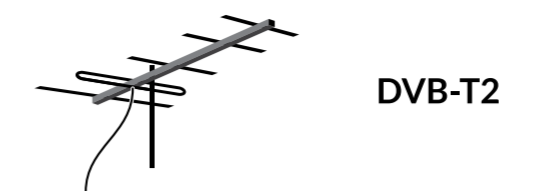
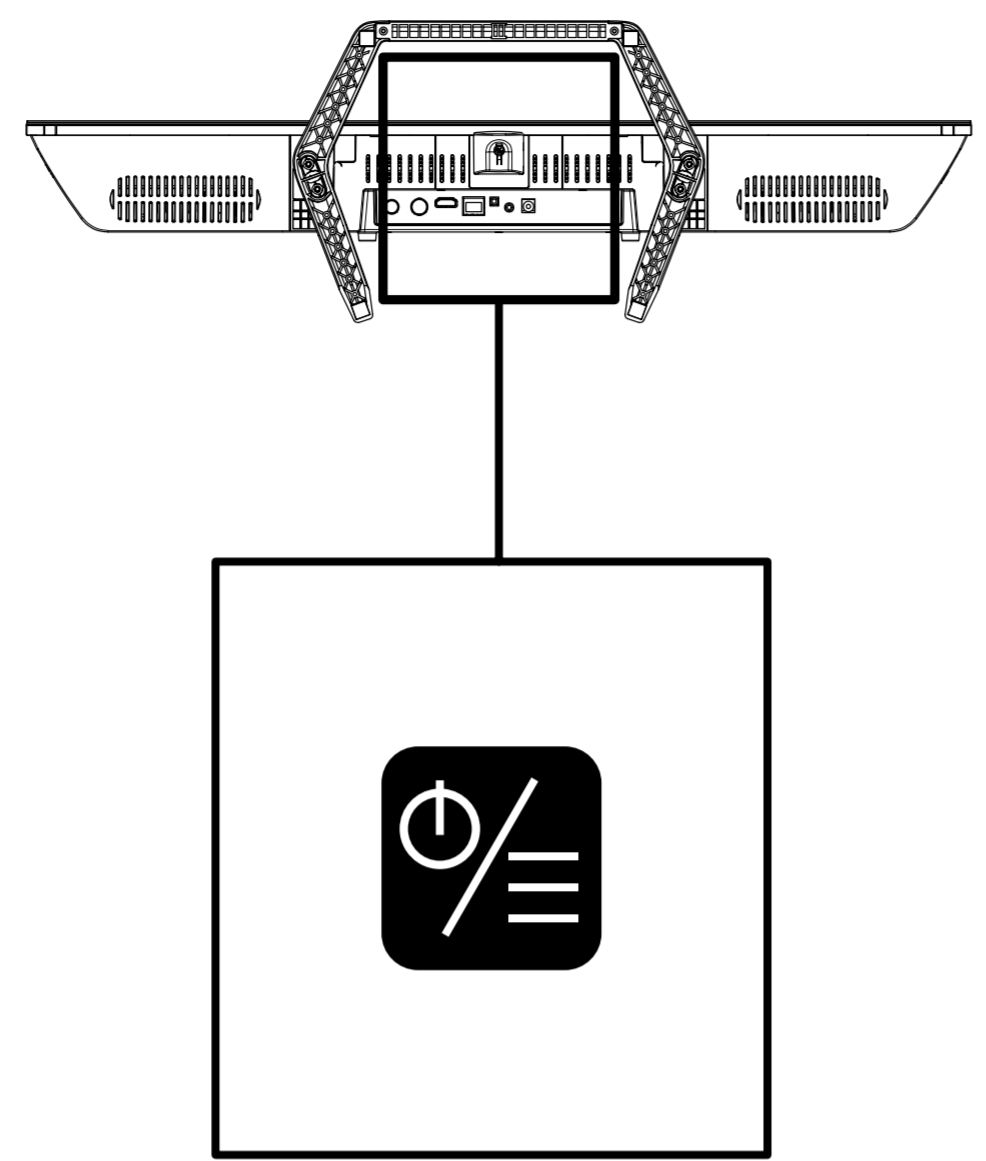
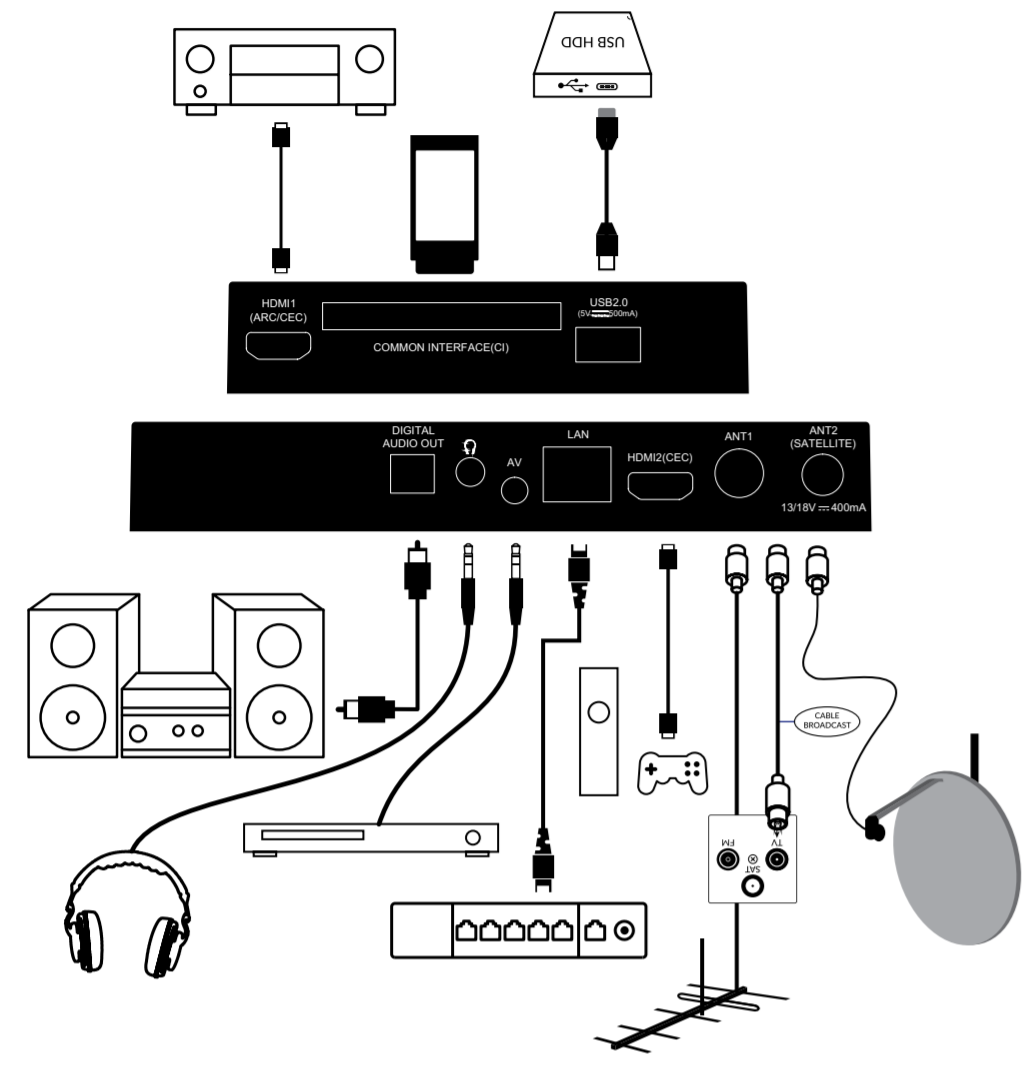

Tuner Mode
Please select your tuner mode:

Antenna
Cable
Satellite

Channel scan
First, please connect antenna.
Then, select which type of channels you want to install.

Digital & analogue channels
Only analogue channels
Only digital channels
Skip scan

Scanning
The channel scan may take a while to complete

Analog Channels: 0
Digital Channels: 0
Progress: 10%

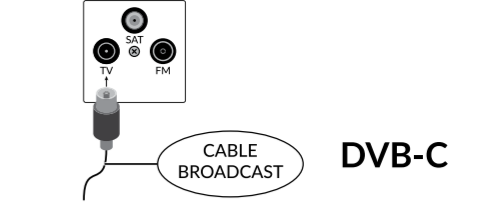
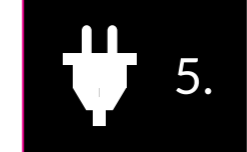

Tuner Mode
Please select your tuner mode:

Antenna
Cable
Satellite
Skip

Select the Operator
You can select only one operator from the following list.

Ziggo
Other

Channel scan
First, please connect antenna.
Then, select which type of channels you want to install.

Only digital channels
Only analogue channels
Digital & analogue channels
Skip scan

Cable Scan Configure
Please configure the cable info.
Use "ENTER" key to setting value and "RIGHT" key to next page.
Please tune to your country home mux transponder frequency.

Scan Mode
Advance
Frequency (KHz)
474000
Network ID
5555

Scanning
The channel scan may take a while to complete

Digital Channels: 0
Progress: 10%

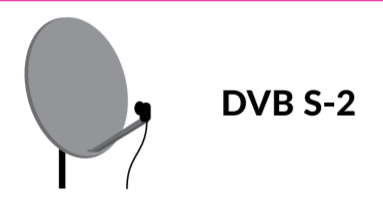

Tuner Mode
Please select your tuner mode:

Antenna
Cable
Satellite

Antenna type
Please select the change of your satellite aerial connexion to e.g define muple satellite positions (more) or to use the single satellite position setup (next) by using arrows up/down and pressing OK.

More
Next

Satellite Antenna Type

DiSEqC 1.0
Single DiSEqC 1.2
Tone Burst Unicable I
DiSEqC 1.1 Unicable II

Select the Operator
Please select your operator by using arrows up/down and pressing OK.

Fast Scan (channel list)
Joyne netherlands Joyne Belgium General

LBN List
Next
Astra4A/SES5 5E on Eutelsat 7E off
Eutelsat off Hotbird off

Channel scan
First, please connect satellite.
Then, select which type of channels you want to install.

Only digital channels
Skip Scan

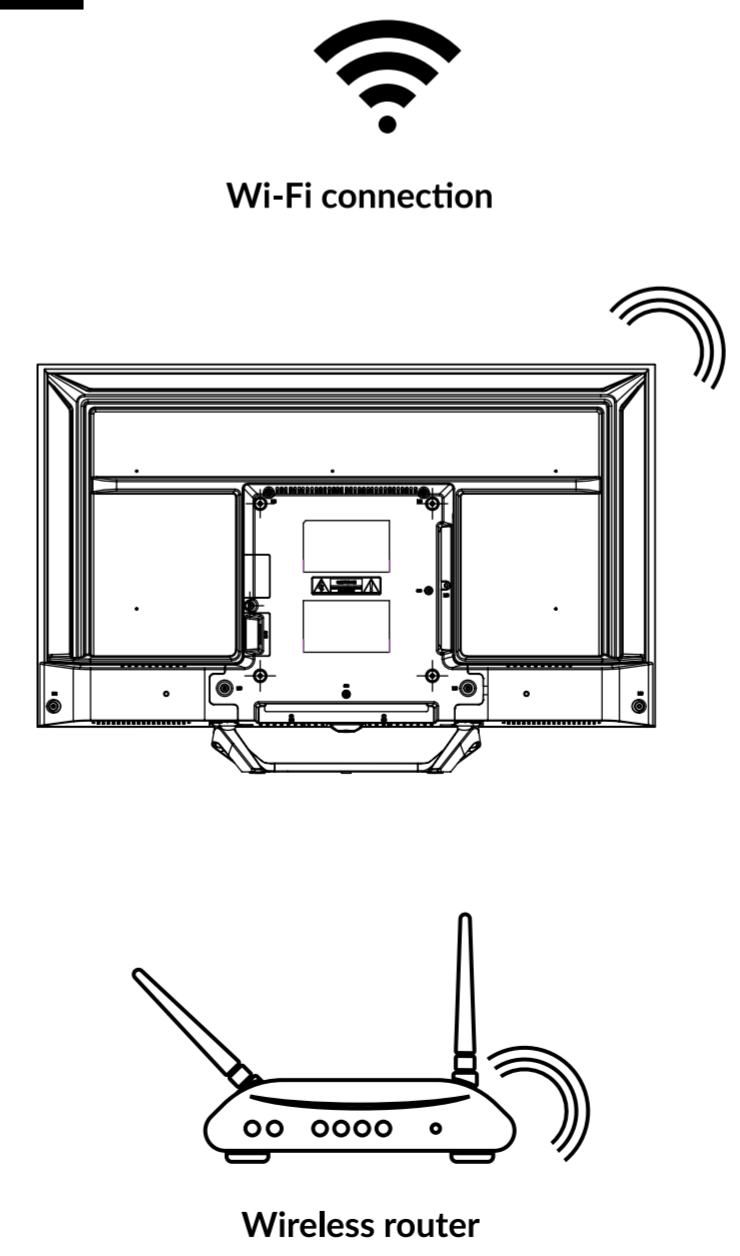
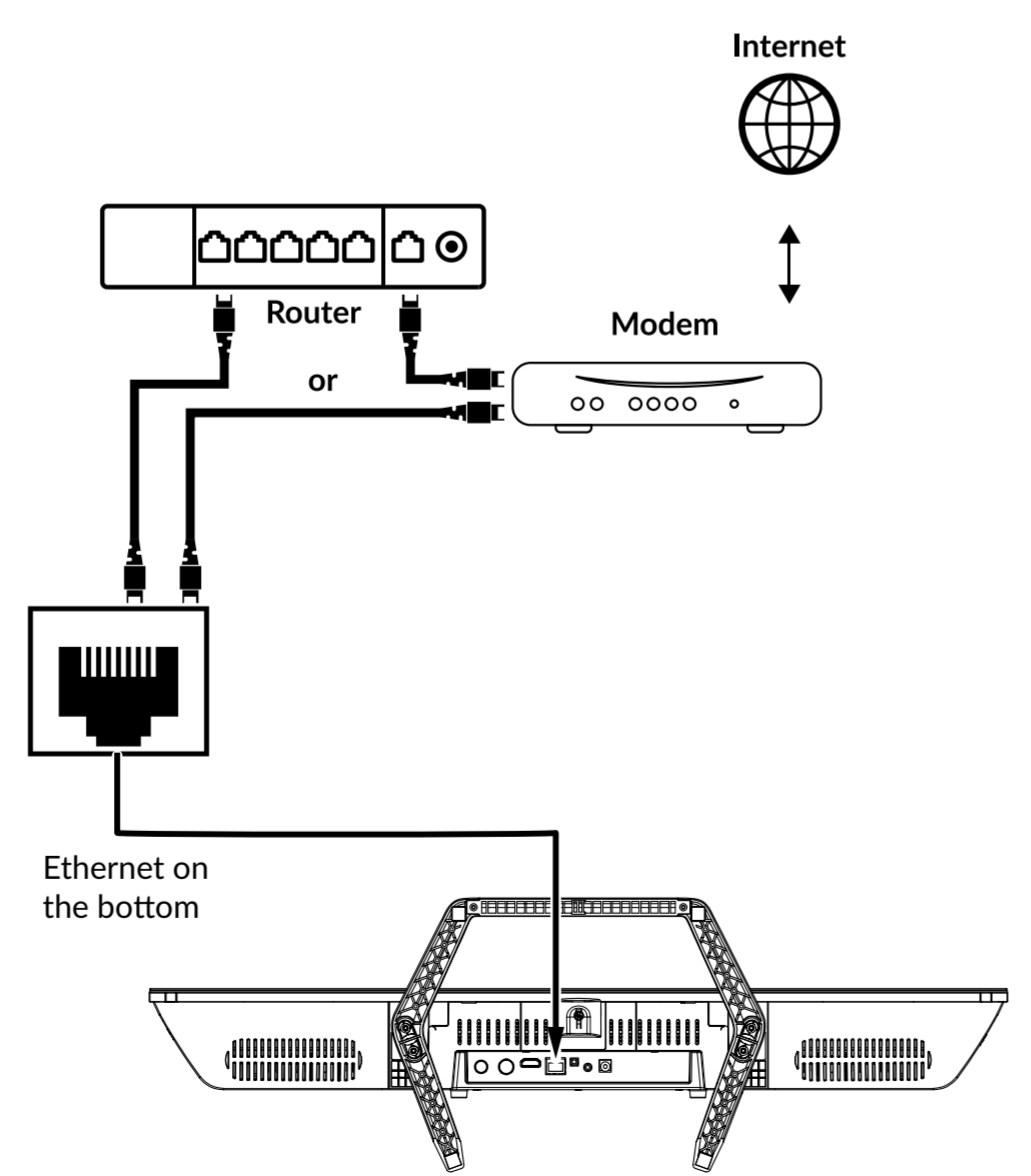

Disclaimer:
Please be aware that STRONG, its manufacturing partners, the application providers and the providers of the services may collect and use technical data and related information, including but not limited to technical information about this device, system and application software and peripherals. STRONG, its manufacturing partners, the application providers and the providers of the services may use such information to improve its products or to provide services or technologies to you, as long as it is in a form that does not personally identify you. Additionally, please keep in mind that some services provided - already in the device or installed by you - may request a registration for which you have to provide personal data. Besides that, please be aware that some services which are not pre-installed but can be installed may collect personal data even without providing additional warnings and that STRONG cannot be held liable for a possible breach of data protection by services not pre-installed.

Licenses
This product contains one or more programs protected under international and U.S. copyright laws as unpublished works. They are confidential and proprietary to Dolby Laboratories. Their reproduction or disclosure, in whole or in part, or the production of derivative works therefrom without the express permission of Dolby Laboratories is prohibited. Copyright 2003-2009 by Dolby Laboratories. All rights reserved.

THIS PRODUCT IS SOLD WITH A LIMITED LICENSE AND IS AUTHORIZED TO BE USED ONLY IN CONNECTION WITH HEVC CONTENT THAT MEETS EACH OF THE THREE FOLLOWING QUALIFICATIONS: (1) HEVC CONTENT ONLY FOR PERSONAL USE; (2) HEVC CONTENT THAT IS NOT OFFERED FOR SALE; AND (3) HEVC CONTENT THAT IS CREATED BY THE OWNER OF THE PRODUCT. THIS PRODUCT MAY NOT BE USED IN CONNECTION WITH HEVC ENCODED CONTENT CREATED BY A THIRD PARTY, WHICH THE USER HAS ORDERED OR PURCHASED FROM A THIRD PARTY, UNLESS THE USER IS SEPARATELY GRANTED RIGHTS TO USE THE PRODUCT WITH SUCH CONTENT BY A LICENSED SELLER OF THE CONTENT. YOUR USE OF THIS PRODUCT IN CONNECTION WITH HEVC ENCODED CONTENT IS DEEMED ACCEPTANCE OF THE LIMITED AUTHORITY TO USE AS NOTED ABOVE.

SIMPLIFIED EU DECLARATION OF CONFORMITY
Hereby, STRONG declares that the radio equipment type SRT 32HG6733C is in compliance with Directive 2014/53/EU. The full text of the EU declaration of conformity is available at the following internet address: <https://eu.strong-eu.com/downloads/>

Subject to alterations. In consequence of continuous research and development technical specifications, design and appearance of products may change. Manufactured under license from Dolby Laboratories. Dolby, Dolby Audio, and the double-D symbol are trademarks of Dolby Laboratories Licensing Corporation. The terms HDMI, HDMI High-Definition Multimedia Interface, and the HDMI Logo are trademarks or registered trademarks of HDMI Licensing Administrator, Inc. Wi-Fi is a registered trademark of Wi-Fi Alliance®. Netflix is a registered trademark of Netflix, Inc. Youtube™ is a trademark of Google Inc. All product names are trademarks or registered trademarks of their respective owners. Availability of application may vary per country. ©STRONG 2024. All rights reserved.