

Preface

STRONG reserves the right to revise this publication and to make changes to the content within without obligation to provide notification.

STRONG reserves the right to make improvements to the design and functionality of the product.

For the latest product details and firmware versions please refer to STRONG Website: www.strong-eu.com.

Trademarks ©STRONG 2024. All rights reserved. STRONG and the STRONG logo are the registered trademarks of STRONG.

This publication may not be reproduced in whole or in part without prior express written permission from STRONG.

Thank you for purchasing a STRONG internet protocol camera we hope you find the features available meet all your needs.

Package content

The contents listed are for reference only, please refer to the actual packing list.



NVR



Quick Start Guide



Cable



Screws



Mouse

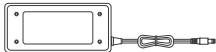

Power Adapter



IEC connector

HDD not included

Appearance

* Design subject to change

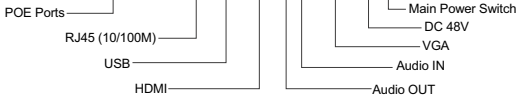
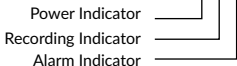
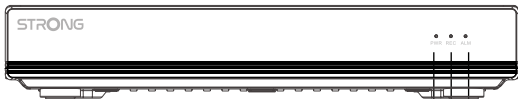

Installation

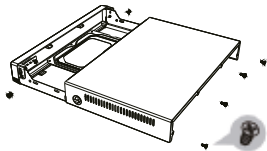

1. Remove the screws that lock the upper and lower covers.

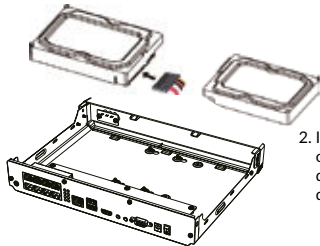

2. Insert the SATA data cable on the mainboard into the data interface of the hard disk to be installed.

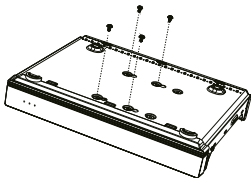

3. Adjust the position of the hard disk, making sure that the screw hole of the hard disk faces down and the data port of the hard disk faces the same direction as the arrow at the bottom.

Align the screw hole of the hard disk with the screw hole of the video recorder (bottom shell), and lock the screw.

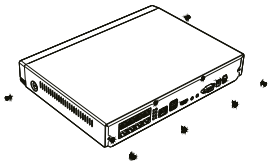

4. Close the upper and lower covers and lock the screws of the NVR.

Download and install the APP for IOS & Android devices

Using the image below scan the QR code using your mobile device. The link will take you to the Apple APP or Google Play Store where you will find "Vision by STRONG". Alternatively visit the Apple APP or Google Play Store and search for "Vision by STRONG". Download the APP onto your Apple or Android device.



First Time Camera Installation

- Open up the “Vision by STRONG” APP on your mobile device.
- Scroll down and select your Country
- You will now see a “Signing Up” page.
- If this is your first time install AND you do not have an account then follow these steps
 - 1. Enter your email address on the top line.
 - 2. Once entered select “SEND” on the second line and wait for a one time code to be sent to your email address.
 - 3. Once you have received the code, please enter it on the second line of the sign in page.
 - 4. Please tick the box to acknowledge you have read the USER SERVICE AGREEMENT.
 - 5. Click NEXT
- You will now be asked to enter a secure password and then retype it to confirm. Follow the onscreen instructions and click “CONFIRM”.



- You will need to record and keep this password safe as it will be needed for future use of the APP.
- The next screen you see will be the account login screen.
- Enter your email address and your newly created password.



- Remove the camera from the packaging.

To connect the camera:

- With a POE power supply, connect the camera directly to the NVR
- Or plug the PSU into the mains and connect the camera to the PSU. Connect the camera to the internet via a router/switch or NVR.
- In the APP select "ADD A DEVICE" and follow the instructions to add the NVR.



- Once completed you will be asked to choose a name for your camera.
- Once done select "COMPLETE".

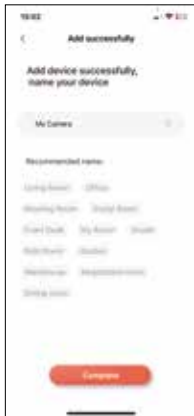

- You are now able to access all the features the NVR has to offer.



Connect to the NVR

1. Connection

Connect the camera(s) and the NVR to the same LAN (Local Area Network), see below for the basic topology diagrams.

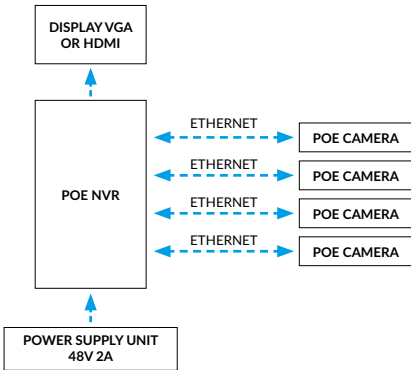

2. Check Video

The monitor will show the live view of the camera(s) after the devices are correctly deployed.

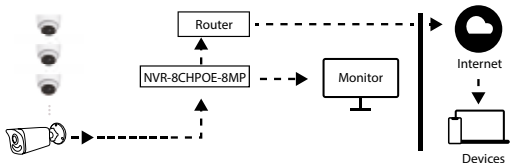

*This figure is for reference only. Please refer to the actual application interface.

Specification

Product Name	8 PORTS POE NETWORK VIDEO RECORDER
MODEL	NVR-8CHPOE-8MP-UK
Power Supply	DC 48V \equiv 2A
POE:	8xRJ45 (10/100Mbps) PoE budget 14W max./port, total budget 56W max.
Environment	Working Temp -10°C~ 40°C Humidity: <90% (subject to HDD working temperatures) Storage Temp -15°C ~ 55°C Humidity: < 95%

Warranty

The host is guaranteed for 2 years from the date of purchase:

1. During the warranty period, due to the failure of the product itself, please contact our after-sales service.
2. After purchasing the machine, please fax the completed warranty card in time, so that you can enjoy free maintenance and replacement, otherwise it will not be handled.
3. We will use your warranty card information when repairing, please fill in carefully.
4. The following cases belong to the scope of paid warranty:
 - Human-caused equipment failure
 - Failure caused by the environment that does not meet the requirements of this product
 - Product damage caused by a force majeure event
 - There is no product serial number, warranty card, or the product serial number and label are too blurred to be identified
 - Warranty expired.

Attention

- The equipment should be installed horizontally in a well-ventilated place, with a minimum gap of 10cm around, and do not cover items such as newspapers.
- Please install the product in a stable place to prevent it from falling.
- The equipment must not be exposed to water droplets or splashes, and objects filled with liquids, such as vases, must not be placed on the machine.
- Please keep the product away from humidity, exposure to sunlight and high temperature, and also away from items with magnetic force.
- Avoid scratching the case and interface, and avoid the product being damaged by dropping, throwing or being subjected to a strong impact.
- Please use an exclusive power adapter to prevent damage to important parts on the mother-board due to excessive current.
- Please do not try to disassemble the product by yourself, the maintenance work is only carried out by the staff authorized by our company.
- Batteries must not be exposed to overheated environments.
- The external power adapter is used as a power disconnection device, please pay attention to safe plugging.
- The input and output interfaces of this product are only suitable for Class II equipment.

- Pay attention to lightning protection when connecting communication cables. It is strictly forbidden to directly connect the Ethernet cable introduced outdoors to the NVR.
- Please select the hard disk recommended by the manufacturer to meet the read and write requirements for a long time and a large amount of data (<https://eu.strong-eu.com/security-storage-whitelist/>). At the same time, please purchase from official channels to ensure the quality of the hard disk.

Lithium battery safety warning

The CR2032 lithium battery is used inside the device. If other types of batteries are used, there may be a danger of explosion. When replacing the battery, do not throw the old battery into fire or dispose of it with household waste, please dispose of the used battery in accordance with local laws and regulations.



Correct Disposal of this product. This marking indicates that this product should not be disposed with other household wastes through out EU & UK. To prevent possible harm to the environment or human health from uncontrolled waste disposal, recycle it responsibly to promote the sustainable reuse of material resources. To return your used device,

please use the return and collection systems or contact the retailer where the product was purchased. They can take this product for environmental safe recycling.

HDMI™

HIGH-DEFINITION MULTIMEDIA INTERFACE

The terms HDMI, HDMI High-Definition Multimedia Interface, HDMI Trade dress and the HDMI Logos are trademarks or registered trademarks of HDMI Licensing Administrator, Inc.

DECLARATION OF CONFORMITY

The full text of the EU&UK declaration of conformity is available at the following internet address: <https://www.strong-eu.com/downloads/>

This product is in conformity
with the Product Security
and Telecommunications
Infrastructure Act 2022.
Scan below for full statement



[eu.strong-eu.com/
psti-compliance/](https://eu.strong-eu.com/psti-compliance/)