

STRONG

LED TV with DVB-T2/C/S2
SRT40FC4003



User Manual
Bedienungsanleitung
Manuel utilisateur
Manuale utente
Manual do Utilizador
Инструкции за употреба
Руководство пользователя
Посібник користувача
Användar Manual
Uživatelská příručka
Navodila za uporabo

Korisnički priručnik
Uputstvo za rukovanje
Používateľská príručka
Használati útmutató
Käyttöohje
Brukermanual
Manual del Usuario
Gebruiksaanwijzing
Brugervejledning
Manual de Utilizare
Instrukcja obsługi

Fig. 1a

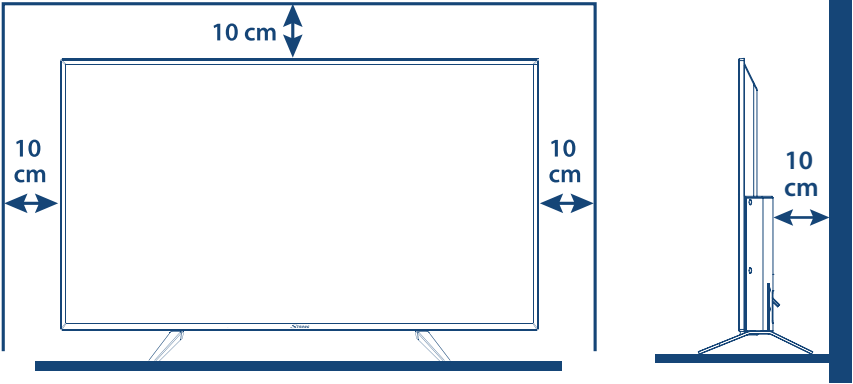

Fig. 1b

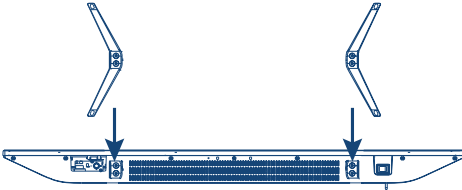

Fig. 1c

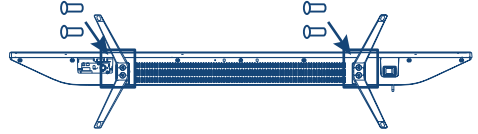

Fig. 2

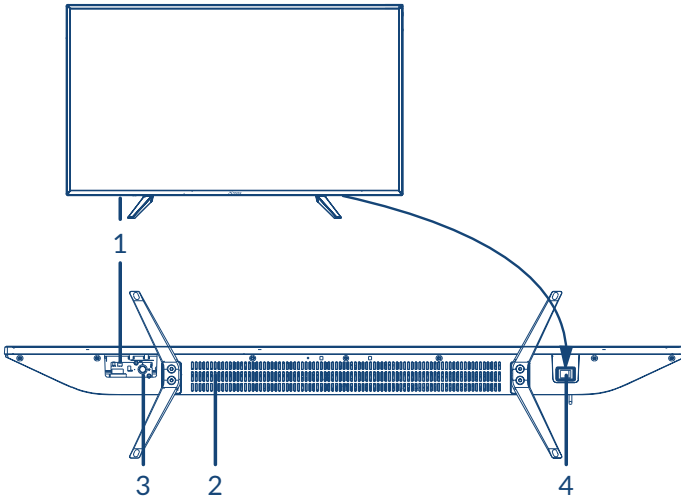

Fig. 3a



Fig. 3b



Fig. 4

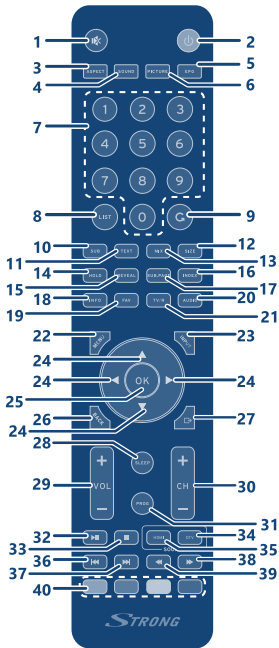

Fig. 5

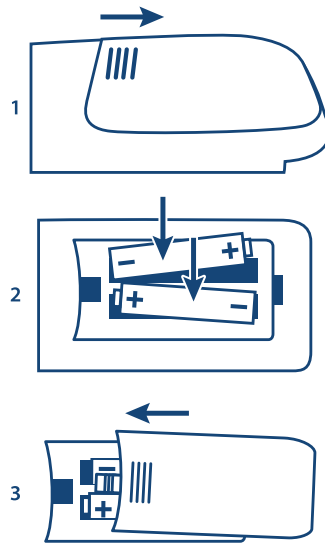

Fig. 6



Fig. 7



Fig. 8



SERVICE CENTER

AT	 support_at@strong.tv  0820 400 150 (€ 0,12/Min. österr. Festnetz)	HU	 support_hu@strong.tv  +36 1 445 26 10
BG	 support_bg@strong.tv  +359 32 634451	IT	 support_it@strong.tv  199 404 032 Da rete fissa 24,8 cent. al min. 12,5 cent. scatto alla risposta Da rete mobile max 49 cent. al min. 15,6 cent. scatto alla risposta
CZ	 support_cz@strong.tv  844 44 44 90	NL	 support_nl@strong.tv
DE	 support_de@strong.tv  0180 501 49 91 (€ 0,14/Min. deutsches Festnetz) (€ 0,42/Min. max. Mobilfunknetze)	PL	 support_pl@strong.tv  801 702 017
DK	 support_dk@strong.tv	PT	 support_pt@strong.tv  +351 2 100 06 125
ES	 support_es@strong.tv  +34 91 119 61 76	SK	 support_sk@strong.tv  0850 15 05 50
FR	 support_fr@strong.tv	SL	 +386 1 828 08 58
HR	 +385 1 344 57 66	UA	 support_ua@strong.tv  +380 (44) 238 61 50

www.strong.tv

Supplied by STRONG Austria
Represented by STRONG Ges.m.b.H.
Teinfaltstraße 8/4, Stock
1010 Vienna, Austria
Email: support_at@strong.tv

Licenses

THIS PRODUCT IS LICENSED UNDER THE AVC PATENT PORTFOLIO LICENSE FOR THE PERSONAL AND NONCOMMERCIAL USE OF A CONSUMER TO (i) ENCODE VIDEO IN COMPLIANCE WITH THE AVC STANDARD ("AVC VIDEO") AND/OR (ii) DECODE AVC VIDEO THAT WAS ENCODED BY A CONSUMER ENGAGED IN A PERSONAL AND NON-COMMERCIAL ACTIVITY AND/OR WAS OBTAINED FROM A VIDEO PROVIDER LICENSED TO PROVIDE AVC VIDEO. NO LICENSE IS GRANTED OR SHALL BE IMPLIED FOR ANY OTHER USE. ADDITIONAL INFORMATION MAY BE OBTAINED FROM MPEG LA, L.L.C. SEE [HTTP://WWW.MPEGLA.COM](http://www.mpegla.com)

This product contains one or more programs protected under international and U.S. copyright laws as unpublished works. They are confidential and proprietary to **Dolby Laboratories**. Their reproduction or disclosure, in whole or in part, or the production of derivative works therefrom without the express permission of Dolby Laboratories is prohibited. Copyright 2003-2009 by Dolby Laboratories. All rights reserved.

THIS PRODUCT IS SOLD WITH A LIMITED LICENSE AND IS AUTHORIZED TO BE USED ONLY IN CONNECTION WITH HEVC CONTENT THAT MEETS EACH OF THE THREE FOLLOWING QUALIFICATIONS: (1) HEVC CONTENT ONLY FOR PERSONAL USE; (2) HEVC CONTENT THAT IS NOT OFFERED FOR SALE; AND (3) HEVC CONTENT THAT IS CREATED BY THE OWNER OF THE PRODUCT. THIS PRODUCT MAY NOT BE USED IN CONNECTION WITH HEVC ENCODED CONTENT CREATED BY A THIRD PARTY, WHICH THE USER HAS ORDERED OR PURCHASED FROM A THIRD PARTY, UNLESS THE USER IS SEPARATELY GRANTED RIGHTS TO USE THE PRODUCT WITH SUCH CONTENT BY A LICENSED SELLER OF THE CONTENT. YOUR USE OF THIS PRODUCT IN CONNECTION WITH HEVC ENCODED CONTENT IS DEEMED ACCEPTANCE OF THE LIMITED AUTHORITY TO USE AS NOTED ABOVE.

Data Protection:

Please be aware that STRONG, its manufacturing partners, the application providers and the providers of the services may collect and use technical data and related information, including but not limited to technical information about this device, system and application software and peripherals. STRONG, its manufacturing partners, the application providers and the providers of the services may use such information to improve its products or to provide services or technologies to you, as long as it is in a form that does not personally identify you.

Additionally, please keep in mind that some services provided - already in the device or installed by you - may request a registration for which you have to provide personal data.

Besides that, please be aware that some services which are not pre-installed but can be installed may collect personal data even without providing additional warnings and that STRONG cannot be held liable for a possible breach of data protection by services not pre-installed.

SIMPLIFIED EU DECLARATION OF CONFORMITY

Hereby, STRONG declares that the device SRT 40FC4003 is in compliance with Directive 2014/53/EU.

The full text of the EU declaration of conformity is available at the following internet address: <https://www.strong.tv/en/doc>

Subject to alterations. In consequence of continuous research and development technical specifications, design and appearance of products may change. Manufactured under license from Dolby Laboratories. Dolby, Dolby Audio and the double-D symbol are registered trademarks of Dolby Laboratories. The terms HDMI and HDMI High-Definition Multimedia Interface, and the HDMI logo are trademarks or registered trademarks of HDMI Licensing Administrator, Inc in the United States and other countries. Wi-Fi is a registered trademark of Wi-Fi Alliance®. Netflix is a registered trademark of Netflix, Inc. YouTube™ is a trademark of Google Inc. All product names are trademarks or registered trademarks of their respective owners.

© STRONG 2021. All rights reserved.

To obtain the best performance and safety, please read this manual carefully. Please keep this manual for future reference.



TABLE OF CONTENTS

1.0 INSTRUCTION	3
1.1 Safety Instructions	3
1.2 Storage	4
1.3 Accessories	4
1.4 Equipment set-up	4
2.0 INSTALLATION	5
2.1 Default PIN code: 0000	5
2.2 Front panel/underside	5
2.3 Rear panel	5
2.4 Side panel	5
2.5 Remote control	6
2.6 Installing the batteries	7
2.7 Using the remote control	7
3.0 FIRST TIME INSTALLATION	7
3.1 DVB-S/S2 installation	8
3.2 DVB-T/T2 installation	8
3.3 DVB-C installation	8
4.0 ELECTRONIC PROGRAMME GUIDE (EPG)	9
5.0 MENU SETTINGS	9
5.1 Menu control (DTV mode)	9
5.2 Picture menu	9
5.3 Sound menu	10
5.4 Channel	10
5.5 Time menu	12
5.6 Lock	12
5.7 Setup Menu	12
6.0 USB	13
6.1 Reminder when using the USB player	13
6.2 USB menu	14
7.0 TROUBLESHOOTING	16
8.0 SPECIFICATIONS	18

1.0 INSTRUCTION

1.1 Safety Instructions

Read all of the instructions before operating the set. Keep these instructions well for later use.

- Only use attachments/accessories specified or provided by the manufacturer (such as the exclusive supply adapter, battery etc.).
- Please refer to the information on the exterior back enclosure for electrical and safety information before installing or operating the apparatus.
- To reduce the risk of fire or electric shock, do not expose this apparatus to rain or moisture.
- The ventilation should not be impeded by covering the ventilation openings with items, such as newspaper, table-cloths, curtains, etc.
- The apparatus shall not be exposed to dripping or splashing and no objects filled with liquids, such as vases, shall be placed on the apparatus.
- The mark  indicates a risk of electric shock. The external wires must be installed by an instructed person or ready-made leads or cords must be used.
- To prevent injury, this apparatus must be securely attached to the floor/wall in accordance with the installation instructions.
- Danger of explosion if the battery is incorrectly replaced. Replace only with the same or equivalent types.
- The battery (battery or batteries or battery pack) shall not be exposed to excessive heat such as sunshine, fire or the like.
- Excessive sound pressure from earphones and headphones can cause hearing loss.
- Listening to music at high volume levels and for extended durations can damage one's hearing.
- In order to reduce the risk of damage to hearing, one should lower the volume to a safe, comfortable level, and reduce the amount of time listening at high levels.
- The mains plug or appliance coupler is used as disconnect device, it shall remain readily operable. When not in use and during movement, please take care of the power cord set, e.g. tie up the power cord set with cable tie or something like that. It shall be free from sharp edges or similar which can cause abrasion of the power cord set. When put into use again, please make sure the power cord is not damaged. In case of damages, please get the power cord replaced by a similar one with the same specifications. The absence of a light indication on the apparatus does not mean that it is fully disconnected from the mains. To disconnect the apparatus completely, the mains plug must be pulled out.
- Attention should be drawn to environmental aspects of battery disposal.
- No naked flame sources, such as lighted candles, should be placed on the apparatus.
-  To prevent the spread of fire, keep candles or other open flames away from this product at all times.
- A USB terminal can provide a maximum of 500 mA.
-  Equipment with this symbol is a Class II or double insulated electrical appliance. It has been designed in such a way that it does not require a safety connection to electrical earth.

Operating Environment

- Do not install this equipment in a confined space such as a bookcase or similar unit.
- Do not use the set near damp, and cold areas, protect the set from overheating.
- Keep away from direct sunlight.
- Do not use the set near dust place.
- Do not attach candle to accessible opening area, to avoid flammable foreign material from entering the TV.

WEEE Directive



Correct Disposal of this product. This marking indicates that this product should not be disposed with other household wastes throughout the EU. To prevent possible harm to the environment or human health from uncontrolled waste disposal, recycle it responsibly to promote the sustainable reuse of material resources. To return your used device, please use the return and collection systems or contact the retailer where the product was purchased. They can take this product for environmentally safe recycling.

1.2 Storage

Your device has been carefully checked and packed before shipping. When unpacking it, make sure that all the parts are included and keep the packaging away from children. We recommend that you keep the carton during the warranty period, to keep your device perfectly protected in the event of repair or warranty.

1.3 Accessories

1. 1x installation instructions
2. 1x safety instructions/warranty cards
3. 1x remote control
4. 2x AAA batteries

1.4 Equipment set-up

Fig. 1a

Install the display on a solid horizontal surface such as a table or desk. For ventilation, leave a space of at least 10 cm free all around the set. To prevent any fault and unsafe situations, please do not place any objects on top of the set. This apparatus can be used in tropical and/or moderate climates.

Stand assembly instruction

Fig. 1b

Carefully place the TV with its front side facing down on a cushioned flat surface in order to protect the TV and the TV screen from damage.

Take out the 2 side feet and assemble them to the TV

Fasten the feet to the bottom of the TV using the 4X14PM (40") screws.

Fig. 1c

This user manual provides complete instructions for installing and using this TV. The symbols serve as follows.

WARNING	Indicates warning information.
NOTE	Indicates any other additional important or helpful information.
MENU	Represents a button on the remote control or the TV. (Bold characters)
<i>Move to</i>	Represents a menu item within a window. <i>(Italic characters)</i>

2.0 INSTALLATION

2.1 Default PIN code: 0000

2.2 Front panel/underside

Fig. 2

NOTE: The graphics are for representation only.

1. Power indicator /remote sensor
2. Speakers
3. Buttons: Input source, Menu, V-/V+, CH-/CH+, Standby/ON.
4. Power switch ON/OFF

2.3 Rear panel

NOTE: The graphics are for representation only.

Fig. 3a

1. **SAT IN** Connect a satellite dish to the TV for searching programmes.
2. **ANT/CABLE IN** Connect a terrestrial antenna or cable connection from your provider to the TV for searching programmes.
3. **CI+** Connect a Conditional Access Module (CAM).
4. **AV IN** 3.5 mm female jack entry for composite video and left/right audio connection.
5. **HEADPHONES** Speakers will be muted when earphone is plugged in and headphone selected.

2.4 Side panel

NOTE: The graphics are for representation only.

Fig. 3b















1. **SCART** Connect devices like DVD or VCR using SCART cable
2. **HDMI 1 (ARC)** Connect HDMI input signal from a signal source such as DVD, Blu-ray player or game console or directly to a Digital Amplifier that supports the ARC function. This input is equipped with the ARC (Audio Return Channel) feature to implement audio connections and for a full Dolby audio support.
3. **HDMI 2** Connect HDMI input signal from a signal source such as DVD, Blu-ray player or game console.
4. **VGA** Connect a VGA source computers may have
5. **USB** Connect a USB device for playback of multimedia files

6. S/PDIF (coax. output)

Use an RCA cable to connect your TV to a compatible digital amplifier or Home theatre set.

2.5 Remote control

Fig. 4

1.  Press to mute or restore the volume.
2.  Press to turn the TV on or standby.
3. (ASPECT)  Change aspect ratio.
4. SOUND Change sound mode.
5. (PICTURE) PIC Change picture mode.
6. EPG Press to display the current EPG information in DTV mode.
7. 0~9 Choose channel directly.
8. LIST Press to enter into the channel list.
9.  Press to go back to previous viewed channel.
10. SUB Enable/disable subtitles in DTV/USB mode.
11. TEXT Press to enter or exit the teletext menu.
12. SIZE Enlarge the teletext display. Press this button once to enlarge upper half of the screen. Press this button again to enlarge lower half of the screen. Press this button again to resume to normal screen size.
13. MIX Press this button to superimpose the teletext over the TV programme. Press again to return to normal teletext mode.
14. HOLD Press to hold the teletext page on screen without update and changes. Press again to release the hold state.
15. (REVEAL) TIP In teletext mode, press to reveal the hidden information.
16. INDEX Press this button to display index page.
17. (SUB.PAGE) SUB.P Press this button to enter or exit subpage mode (if subpage is available). Press the   buttons to select a subpage.
18. INFO Display information about the current source.
19. FAV Press to view your assigned favourite list or main list channels. Press   to cycle through your assigned favourite channels, press **OK** to confirm. To open the selected list directly, you can press the **LIST** button.
20. AUDIO Press to select available audio languages. Selecting audio description, a narrator will describe what is happening on the screen for blind or visually impaired viewers. Press again to turn it off (depending on broadcast).
21. TV/R Switch between TV and radio.
22. MENU Open the menu options. Step back in some menu options.
23. INPUT Select the input source mode.
24.     Navigate the menu.
25. **OK** Confirm the selection.
26. **BACK** Step back in some menu options
27.  Exit the current menu.
28. **SLEEP** Select the sleep time, such as 10 min, 20 min etc.
29. **VOL +/-** Adjust the volume up or down.
30. **CH +/-** Change programmes up or down. Big steps in Channel list.
31. **PROG** Press to enter the Programme Edit menu.
32.  **II** Start/Pause playback, press again to continue playback.
33.  Press to stop playback.
34. **DTV** Press to go back to Digital TV.
35. **HDMI** Press several times to select your HDMI input.

- 36. ⏮ Press to play the previous file.
- 37. ⏭ Press to play the next file.
- 38. ⏩ Press to fast forward.
- 39. ⏪ Press to fast reverse.
- 40. COLOUR BUTTONS
Press to execute the prompt function in TV or DTV menu mode.

2.6 Installing the batteries

Fig. 5

Place 2x AAA batteries in the battery compartment of the remote control. Make sure to match the polarity markings inside the compartment.

NOTE: Pictures are only for reference. Actual items may differ.

1. Slide the cover horizontally.
2. Put 2x AAA batteries in the compartment and make sure the polarity is correct.
3. Slide horizontally to close the cover.

Precautions for using the battery

Improper using of the battery will cause leakage. Carefully follow these instructions.

1. Please note the batteries' polarity to avoid short circuit.
2. When the battery's voltage is insufficient which affect the use range, you should replace it with a new battery. Remove the batteries from the remote control unit if you do not intend to use it for a long time.
3. Do not use different types of batteries (for example Manganese and Alkaline batteries) together.
4. Do not put the battery into fire, and charge or decompose the battery.
5. Please dispose batteries abide by relevant environmental protection regulation.

2.7 Using the remote control

- Use the remote control by pointing it towards the remote sensor. Items between the remote control and the remote sensor could block normal operation.
- Do not cause the remote control to vibrate violently. Also, do not splash liquid on the remote control, also do not put the remote control in a high humidity place.
- Do not place the remote control under direct sunlight which will cause deformation of the unit by heat.
- When the remote sensor is under direct sunlight or strong lighting, the remote control will not work. If so, please change the lighting or TV's position, or operate the remote control closer to the remote sensor.

3.0 FIRST TIME INSTALLATION

After all connections have been properly made, switch on your TV. The language selection will appear on screen. Use ▲▼◀▶ to select the *OSD Language* of your preference. Confirm with **OK** on your remote control.

The next screen appears with the *Mode Selection* to select *Home Mode* or *Shop Mode*. Press **OK** and ◀▶ to confirm.

Then the next screen appears with the tuner selection. Choose the one you like to use.

Scan type

Select which input source you want to use: *DVB-S* to receive satellite broadcasts (and if you are equipped with a satellite dish), *DVB-T* to receive terrestrial broadcasts or *DVB-C* to receive cable broadcasts.

3.1 DVB-S/S2 installation

Satellite Setting

First select the region where you are using the TV. This important to set time zone correct. Use the ◀▶▲▼ and confirm with **OK**.

Press ▲▼ to highlight the satellite your dish is aimed at. Confirm with **OK** to mark the satellite. Use the ◀▶▲▼ buttons to change settings for your satellite installation for each specific satellite. The signal quality bar on the bottom of the screen allows you to fine tune the alignment of your antenna for optimum reception. Adjust your antenna for maximum possible signal quality. When the signal cannot be improved anymore, fix the dish on this position and press the **BLUE Scan** button to continue.

Channel Search

Press ▲▼ ◀▶ to highlight the options of choice and press **OK** to start the channel search.

<i>Scan Mode</i>	Choose between <i>Default</i> (recommended), <i>Blind Scan</i> , <i>Network</i> and <i>Preset Channel List</i> .*
<i>Crypted</i>	Select <i>FTA Channels</i> to search Free-To-Air channels only or <i>All Channels</i> to search FTA and Encrypted channels
<i>Service Type</i>	Select <i>DTV</i> to search DTV channels only, <i>RADIO</i> to search radio channels only or <i>All</i> for a complete search.

It is recommended to use the default settings.

3.2 DVB-T/T2 installation

Terrestrial Setting

First select the Tune Type by pressing ◀▶ to select *DTV*, *ATV* or *DTV+ATV* (DTV to search digital broadcasts and ATV to search analogue broadcasts). Press ▼ to continue. Press ◀▶ to select *All Channels* or *FTA Channels*. Press ▲▼ ◀▶ to highlight the country that you want to install, then press **OK** to start searching.

3.3 DVB-C installation

Cable Setting

Press ▲▼ ◀▶ to highlight your settings.

<i>Scan type</i>	You can select <i>Network Scan</i> or <i>Full</i> . (Default <i>Network Scan</i> for quick search advised)
------------------	--

NOTE: *Full scan* will have a duration of approximately 20 minutes, depending on your cable network.

<i>Frequency</i>	Please enter (with 0 ~ 9) the main frequency used by your provider in KHz.
<i>Network ID</i>	Please enter (with 0 ~ 9) the used <i>Network ID</i> from your provider.
<i>Symbol</i>	Please enter (with 0 ~ 9) the used <i>Symbol</i> from your provider. (Ks/s)

NOTE: Please check the settings for your cable system used by your provider!

Press **OK** to continue.

Crypted Select *FTA Channels* to search Free-To-Air channels only or *All Channels* to search FTA and encrypted channels

Press **▲▼◀▶** to highlight the country that you want to install, then press **OK** to start searching.

4.0 ELECTRONIC PROGRAMME GUIDE (EPG)

EPG stands for Digital Electronic Programme Guide. It is supplied by the programme providers and offers information on broadcasted programmes. You can access it in digital mode by pressing **EPG** on the remote control. Press **EPG** to bring up the EPG interface. Use **▲▼** to select a programme. Press **EXIT** to stop and return to viewing modes.

Then press the **COLOUR BUTTONS** for entering the required settings.

- GREEN** Access extra info of programme
- YELLOW** Open the reminder setting over view
- BLUE** Set reminder of selected programme.

5.0 MENU SETTINGS

Below items depend if they are available of select input source. Use **INPUT** to select another source.

5.1 Menu control (DTV mode)

Press **MENU** to enter the main menu. Press **◀▶** to select an item. Press **▲▼** and **OK** to select the submenus. Press **MENU** to exit the item.

5.2 Picture menu

- Picture Mode* Select the automatic picture control mode. Available choices are *Dynamic, Standard, Mild* and *User*.
- Colour Temperature* Select the overall colour tone of the picture. Available choices are *Cool, Medium, Warm* and *User*.
- Aspect Ratio* Select the aspect ratio (display proportions) according to your video signal type or preference. Available choices are *Auto, 4:3, 16:9, Zoom1* and *Zoom2*.
Note: Some options may not be available under some sources.
- Noise Reduction* Eliminates noise in the picture. Available choices are *Off, Low, Middle* and *High*.

In the *User* mode, settings can be changed for *Brightness, Contrast, Colour* and *Sharpness*.

5.2.1 Contrast/Brightness/Colour Tint/Sharpness

If *Picture Mode* is set to *Personal* you are able to change the following settings

Press **▲▼** to select an option, then press **◀▶** to adjust.

- Contrast* Adjust the highlight intensity of the picture, but the shadow of the picture is invariable.
- Brightness* Adjust the optical fibre output of the entire picture, it will affect the dark region of the picture.

<i>Colour</i>	Adjust the saturation of the colour based on your own preference.
<i>Tint</i>	No function
<i>Sharpness</i>	Adjust the peaking in the detail of the picture.

5.2.2 Colour Temperature

In this menu you can change the overall colour cast of the picture.

Press ▲▼ to select *Colour Temperature*, then press **OK** to enter a sub-menu. Press ▲▼ to select the relevant picture effect (DEFAULT: *Cold Normal Warm*).

<i>Cold</i>	Increase the blue tone for the white.
<i>Normal</i>	Increase the neutral colours for the white.
<i>Warm</i>	Increase the red colour for the white.

5.2.3 Noise Reduction

In this menu you can filter out and reduce the image noise and improve picture quality. Press ▲▼ to select *Noise Reduction*, then press **OK** to enter a sub-menu.

<i>Off</i>	Select to turn off video noise detection.
<i>Low</i>	Detect and reduce low video noise.
<i>Middle</i>	Detect and reduce moderate video noise.
<i>High</i>	Detect and reduce enhanced video noise.
<i>Default</i>	Set as Default.

5.3 Sound menu

<i>Sound Mode</i>	Select your favourite sound mode for each input. Choices are <i>Standard, Music, Movie, Sports</i> and <i>User</i> .
<i>Bass</i>	Adjusts the lower frequency of the sound.
<i>Treble</i>	Adjusts the higher frequency of the sound.
<i>Balance</i>	Control the sound balance between the right and left loudspeaker (earphone).
<i>Auto Volume</i>	Adjust the volume corresponding to the input audio level. Options are <i>On</i> and <i>Off</i> .
<i>Surround Sound</i>	Turns on the Sound Retrieval System.
<i>AD Switch</i>	Turn on the <i>Audio</i> description, you can activate the setting of AD volume. When turn on the audio description, a narrator will describe what is happening on the screen for blind or visually impaired viewers. (Only if available in DTV mode.)
<i>S/PDIF Mode</i>	If you have connected S/PDIF output to digital home audio system. You can select "Auto" to output Dolby audio automatically. If channel have this audio channel.

5.4 Channel

Press **MENU** to display the main menu. Press ◀▶ to select *Channel* in the main menu. Press ▲▼ to select the option you wish to adjust in the *Channel* menu.

Press **OK** to adjust. After finish your adjustment, press **OK** to save and return to the previous menu. Below items depend if they are available of select input source. Use **INPUT** to select another source.

5.4.1 Auto Tuning

Press **▲▼** to select *Auto Tuning*, select the *Scan Type* and proceed with **OK**.

5.4.2 Dish Setup

If you use *DVB-S/S2* as input source, the *Dish Setup* menu allow you to set you satellite and belonging settings as DiSEqC port and LNB type. Afterwards you may start the *Auto Tuning* or *Manual Tuning* by selecting with *EPG* button the wanted transponder.

5.4.3 DTV Manual Tuning (in DVB-T mode only)

Search and store programmes manually. Press **▲▼** to select *DTV Manual Tuning*. Then press **OK** to enter the sub-menu.

Press **◀▶** to select a *Channel No.*, and then press **OK** to start the search. The search stops when a programme is found and this programme will be stored in the current channel position. If you want to stop the search, press **MENU**.

5.4.4 ATV Manual Tuning (in DVB-C mode only)

First select the source type of ATV. Then in the *Channel menu*, select *ATV Manual Tuning* and press **OK** to access. Highlight and press **▲▼** to select *Storage To 1* (maybe other number), *Sound System* and *Channel No.*. Then select search and press **OK** to start the search. Press **▶** for the unit to search towards higher frequency. Press **◀** for the unit to search towards lower frequency. The search stops when a programme is found and this programme will be stored in the current channel position. If you want to stop the search, press **MENU**.

<i>Current CH</i>	Set the channel number
<i>Colour System</i>	Select the colour system (Available: AUTO, PAL, SECAM)
<i>Sound System</i>	Select the Sound system
<i>Fine-Tune</i>	Adjust the frequency of the channel
<i>Search</i>	Start the channel search

5.4.5 Channel extra settings

<i>Programme Edit</i>	Edit the programmes. You can press the COLOUR BUTTONS on the remote control to skip programmes, rename and delete programmes or move programmes, and add programmes to the favourite list by pressing FAV .
<i>Signal Information</i>	Showing the information of current DTV channel. Only available with DTV signal.
<i>CI information</i>	Enables the user to watch and change settings of CAM modules and check values from inserted smart card.
<i>Channel list</i>	Select which channel list you like to see if you press on LIST button. Select between <i>Main List</i> or <i>Favorite List</i>
<i>Schedule List</i>	Press ▲▼ in the <i>Channel</i> . Select <i>Schedule List</i> , then press OK to enter the sub-menu. Use the COLOUR BUTTONS to modify your settings.
<i>Software Update (USB)</i>	Press OK and use ◀▶ to select <i>Yes</i> if you want to update the software or <i>No</i> to go back to the main menu. For more information see also chapter 6.2.5.

NOTE:

To modify the order of the channels contained in the channel list do as follow: press **Menu** and **OK** to select *Program Edit* (it is also possible access this option by pressing **PROG** button on the remote control).

To move a channel, select it by using **▲▼** or **CH +/-** button then press **YELLOW** button. Now, there are two different ways to move the channel:

Enter the number of the new position by using the **0 ~ 9** buttons on the remote control and confirm with **OK** or **YELLOW**. The selected channel will be automatically moved to the new position.

Press **▲▼** button and move the channel in a position of your choice. Confirm with **OK**

5.5 Time menu

Press **MENU** to display the main menu. Press **◀▶** to select *TIME* in the main menu. Press **▲▼** to do further adjustments. Press **OK** to return to the previous menu.

Clock The time is automatically obtained from the channel transmission and doesn't have to be set manually. Should this function not be provided by the broadcaster, it is possible to set it by pressing **OK** and set date and time by pressing **▲▼◀▶**.

Time Zone Press **▲▼◀▶** to select *Time Zone*.

Sleep Timer Press **▲▼** to select *Sleep Timer*. Available Options: *Off, 10 min., 20 min., 30 min., 60 min., 90min., 120 min., 180 min. and 240 min..*

Auto Standby This function allows you to set the automatic shutdown of your TV. Choose between *2H, 3H, 4H or Off* to disable this function.

OSD Timer This function allows you to choose how long the info banner is displayed. Choose between *5s, 15s or 30s*.

5.6 Lock

Press **MENU** to display the main menu. Press **◀▶** to enter the *Lock* menu settings. Press **▲▼** to select the options. The following options are available:

System Lock This option allows you to enable or disable the password protection. Press **OK** to set this function *On* or *Off*.

Set Password The default password is **0000**, to customize the password press **OK** and follow the instruction within the menu.

Channel Lock This option allows you to prevent viewing of one or more channels. Press **OK** to display the channel list and select with **▲▼** the channel you want to be locked. Press **GREEN** to lock it. Consider the same procedure to lock other channels if needed.

Parental Guidance Press **OK** to enter and set the age for suitable programmes for children, then press **▲▼**.

5.7 Setup Menu

Language Select the *Menu language* of your choice. The default setting is *English*. Press **▲▼** to select the menu language.

Audio Languages Press **◀▶** to select *Primary* for main audio track or *Secondary* next audio channel if first is not available. Press **▲▼◀▶** to select your chosen *Audio Language*, then press **OK**.

<i>Subtitle Language</i>	Press ▲▼◀▶ to select your chosen <i>Subtitle Language</i> , then press OK
<i>Country</i>	This item shows the region you been selected by first time you install the TV.
<i>Restore Factory Default</i>	Press ▲▼ to select this function, by pressing OK and enter the PIN code. You will reset all the settings contained in the main menu and deleted all installed channels. TV will go back to <i>First Time Installation</i> See chapter 3.
<i>Version Information</i>	Your current software version is displayed.
<i>HDMI CEC</i>	See chapter 5.7.1.
<i>Home /Shop</i>	Switch between <i>Home</i> modes and <i>Shop</i> modes with default more brightness and Auto standby to off.
<i>USB Clone</i>	This option allows you to copy you channel list to USB device as back up. Insert USB device and select <i>Back up</i> . To load this later back into TV, select "Restore".

5.7.1 HDMI CEC

<i>CEC Control</i>	Press ◀▶ to turn the HDMI CEC <i>On</i> or <i>Off</i> .
<i>Audio Receiver</i>	Press ◀▶ to turn the Audio Receiver <i>On</i> or <i>Off</i> .
<i>Device Auto Power Off</i>	Press ◀▶ to turn on this feature. When finished turn off your TV. The connected device will turn off automatically.
<i>TV Auto Power On</i>	Press ◀▶ to select this option. When finished, turn on the connected device. The TV will switch on automatically.
<i>Device List</i>	Press OK to open the main menu of device.
<i>Device Menu</i>	Access the device menu.

6.0 USB

6.1 Reminder when using the USB player

Some USB storage devices may not be compatible to operate smoothly with this TV.

Back up all of the data in the USB storage device in case data is lost due to an unexpected accident. STRONG does not assume any liability for the losses by misuse or malfunction. Data backup is consumer's responsibility.

For large file sizes, the loading speed may be slightly longer.

The recognition speed of a USB storage device may depend on each device.

When connecting or disconnecting the USB storage device, make sure the TV is not in USB mode otherwise the USB storage device or the files stored in it may be damaged.

Please use only a USB storage device which is formatted in FAT16, FAT32, NTFS (playback only) file system provided with the Windows operating system. In case of a storage device formatted as a different utility programme which is not supported by Windows, it may not be recognized.

When using a USB Hard Disk Drive which is not powered independently, ensure its power does not exceed 500 mA. Otherwise the TV system will change into standby mode, and you must pull out the USB Hard Disk and restart the TV system.

An "Unsupported File" message will be displayed if the file format is unsupported or the file is corrupted.

FHD big picture needs longer time to process, which is not caused by the TV. Please be patient.

This TV may not support some multimedia files changed and upgraded as the change of the encoding format or other technical aspects advances.

Please refer to chapter 9. **Appendix** for a list of supported file formats for USB playback.

6.2 USB menu

Press **SOURCE** and select **USB**. You can view movie, music and photo files from your USB storage devices. Connect a USB storage device to the USB input terminal and select the types of media on the home page: *Movie, Music, Photo* and *text*. Press **OK**, the screen will show the connected USB device, press **OK** again to view the file folders and files. Press **▲▼** or **◀▶** to select a folder, press **OK** to open the folder and select the files. Highlight the one you want to play or watch or press directly **▶||** to start playing directly. Press **■** to stop playing and return to upper level folder. Continuously press **RETURN** to go back to upper level folder. Repeat again to select and play another media type.

NOTE:

By choosing one of the three media types, for example *Movie*, the folders inside will display only video files and no other formats.

6.2.1 Play movies

Fig. 6

During playback, press **INFO** or **OK** to display/exit the menu bar (**Fig. 6**). Press the **USB control buttons** on the remote control to do relevant operations.

Play & Pause/Stop/Prev./Next

Press **▶||** to play or pause the playback. Press **■** to stop playing. Press **◀▶** to play the previous or the next video file. Press **INFO** and use **◀▶** to highlight the corresponding icon on the control bar, then press **OK**. The TV will response accordingly.

Fast Reverse/Fast Forward

Press and hold **◀▶** for seconds to draw the playing progress as your desire, then press **▶||** to start the playing from the new position.

Play Mode

Highlight the corresponding icon and press **OK** to switch to another play mode.

Information

Highlight the corresponding icon and press **OK** to view the information of the playing video.

Aspect Ratio

Highlight the button and press **OK** to select the display mode.

6.2.2 Play music

Fig. 7

Press **INFO** or **OK** to display/exit from the menu bar (**Fig. 7**). Press the **USB control buttons** on the remote control to do relevant operations.

Play & Pause/Stop/Previous/Next

Press **▶||** to play or pause the playback. Press **■** to stop playing. Press **◀▶** to play the previous or the next music file. Press **◀▶** to highlight the corresponding icon on the control bar, and then press **OK**. The TV will response accordingly.

Fast Forward/Fast Reverse

Press and hold **◀▶** for seconds to draw the playing progress as you wish, then press **▶||** on the remote control to start playing from the new position.

<i>Repeat</i>	Highlight the icon and press OK . You can select 3 different modes: <i>None</i> to disable the function, <i>1</i> to repeat one track only and <i>All</i> to repeat the entire list once it is finished.
<i>Information</i>	Highlight the icon and press OK to check the information of the playing music.

NOTE:

- If one (or more) file(s) of the play list is selected, the buttons **⏮ ⏭** will play only selected files.
- This menu only shows supported files.
- Files with other file extensions are not displayed, even if they are saved on the same USB storage device.
- An over-modulated mp3 file may cause some sound distortion during playback.
- This TV supports lyrics display (in English). The maximum number of characters per line is 48.
- The file name of music and lyrics must be the same in order to display lyrics while the music is playing.
- If you want to show the associated lyrics on the screen with the music, you must store these in the same folder using the same file name with ".lrc" file extensions.

6.2.3 Browse photos

Fig. 8

Press during viewing **INFO** or **OK** to display/exit from the menu bar (Fig.8). Press the **USB control buttons** on the remote control to do relevant operations.

Play & Pause/Stop/Previous/Next

Press **▶ ||** to play or pause the playback. Press **■** to stop playing. Press **⏮ ⏭** to show the previous or the next picture. Press **◀ ▶** to highlight the icon on the control bar, and then press **OK**. The TV will response accordingly.

<i>Repeat</i>	Highlight the icon and press OK . You can select 3 different modes: <i>None</i> to disable the function, <i>1</i> to repeat one track only and <i>All</i> to repeat the entire list once it is finished.
<i>Info</i>	Highlight the button and press OK to check the information of the shown photo.
<i>Rotate</i>	Highlight the icon in the menu bar and press OK to rotate the picture 90 degrees clockwise or counter clockwise.
<i>Zoom In/Zoom Out</i>	Highlight the icon on the menu bar and press OK to zoom in or zoom out of the image.
<i>Move View</i>	When the image is magnified, use this function for convenient check. Highlight this icon, press OK , then press ◀ ▶ ▲ ▼ to move the image.

NOTE: The move function  is only available when the image is enlarged.

6.2.4 Browse text documents

Press ◀▶ to select *Text* in the main menu. Then press ◀▶ to select the drive disk you choose to watch and **OK** to enter. Select the file you want to display by using ▲▼◀▶ and confirm with **OK**. Quit step by pressing **OK**. Press ◀▶ to select *return* and go back to previous menu.

6.2.5 Software update via USB

From time to time you can check if there is an improved software version available. This can be viewed and downloaded from our website www.strong.tv. Search the model number on our website's service support section. If there is an improved software version you can download the file and copy it to the root of a USB device. Then press ▲▼ button to select *Software Update (USB)* from the *SETUP* menu on your TV. Afterwards plug your USB device into the USB slot and press **OK** to update the respective software. Confirm with *Yes* using ◀▶. When the update is completed, remove the USB stick, disconnect your device from the main power supply and plug in again.

7.0 TROUBLESHOOTING

Before calling a service technician, review following information for possible causes and solutions for the problem you are experiencing. If the TV does not work properly after checking it, please contact your local service line or **STRONG** dealer. Alternatively, you can send a support mail via our website www.strong.tv.

Problem	Possible cause and solution
No picture, no sound	<ol style="list-style-type: none"> 1. Check if the fuse or circuit breaker is working. 2. Plug another electrical device into the outlet to make sure it is working or turned on. 3. The power plug is in bad contact with the outlet 4. Check the signal source.
No colour	<ol style="list-style-type: none"> 1. Change the colour system. 2. Adjust the saturation. 3. Try another channel. Black-white programme may be received.
The remote control does not work	<ol style="list-style-type: none"> 1. Change the batteries. 2. The batteries are not installed correctly. 3. Main power is not connected.
No picture, normal sound	<ol style="list-style-type: none"> 4. Adjust the brightness and contrast. 5. Broadcasting failure may happen.
Normal picture, no sound	<ol style="list-style-type: none"> 1. Press the volume up button to increase the volume. 2. The volume is set to mute, press  to restore the sound. 3. Change the sound system. 4. Broadcasting failure may happen.
Unorderly ripples on the picture	It is usually caused by local interference, such as cars, daylight lamps and hair driers. Adjust the antenna to minimize the interference.

Problem	Possible cause and solution
Snowy dots, blocking and interference	<p>If the antenna is located in the fringe area of a television signal where the signal is weak, the picture may be marred by dots, show blocking or break-ups. When the signal is extremely weak, it may be necessary to install a special antenna to improve the reception.</p> <ol style="list-style-type: none"> 1. Adjust the position and orientation of the indoor/outdoor antenna. 2. Check the connection of the antenna. 3. Fine tune the channel. 4. Try another channel. Broadcasting failure may happen.
Radio frequency interference	<p>This interference produces moving ripples or diagonal streaks, and in some case, loss of contrast in the picture. Find out and remove the radio interference source.</p>
Playback of video is causing picture freeze/ macro blocks or similar distortion, especially on HD content.	<p>Read/write speed of your USB device could be too low. Make sure to use a USB storage device with sufficient speed and space. Pen drives (USB sticks) may not support sufficient speed.</p>
No signal or weak signal, intermittent reception.	<ol style="list-style-type: none"> a) Cables might have loosened; moisture might have entered into cables or connectors, heavy rain at present or heavy storm at present. Check the cable connections, LNB and other equipment connected between the LNB and the receiver, or peak the dish. Wait for rain/storm to subside. Ask a local satellite specialist for advice. b) The satellite dish is not pointing at the (correct) satellite(s). Adjust the dish. Ask a local satellite specialist for advice. c) Satellite dish is too small, trees or buildings in path. Change to a larger dish or change position of dish. d) Signal is too strong, dish is oversized. Connect a signal attenuator to the LNB input. Ask a local satellite specialist for advice.
Bad picture/blocking error during heavy rain.	<p>Heavy rain will attenuate satellite signals, below a certain level blocking will occur.</p> <p>Make sure your dish installation is up to standards to minimize rain effects. When in doubt, ask a local satellite specialist for advice.</p>

NOTE:

If the problem persists after these solutions, please contact your local support centre or send a support mail via our website www.strong.tv.

8.0 SPECIFICATIONS

Audio

Audio Output: 8 W

Video

Channel coverage: DVB-T2: 174 MHz-230 MHz; 470 MHz-860 MHz
DVB-C: 50-858 MHz
DVB-S2: 950 MHz-2150 MHz
System: DTV: DVB-T2, DVB-S2, DVB-C
ATV: PAL/SECAM (BG/DK/1)
AV: PAL, NTSC

Connectors

1x ANT/CABLE IN
1x SAT IN
1x SCART
1x CI+
2x HDMI
1x S/PDIF (coax.)
1x AV IN
1x USB
1x VGA
1x HEADPHONES

General Data

Operating voltage: 100 ~ 240 V AC 50/60 Hz
Power consumption: 40": max. 76 W, typ. 52 W
Power consumption in standby: 40": <0.5 W
Operating temperature: -2 °C ~ +35 °C
Storage temperature: -15 °C ~ +45 °C
Operating humidity: 20% ~ 80% RH, non-condensing
Storage humidity: 10% ~ 90% RH, non-condensing
Dimensions (WxHxD) in mm: 40": 901 x 252 x 511,3
Net-weight: 40": 6,4 kg