

STRONG

SMART TV with DVB-T2/C/S2

SRT 32HB5203

SRT 40FB5203



User Manual
Bedienungsanleitung
Manuel utilisateur
Manuale utente
Manual do Utilizador
Инструкции за употреба
Руководство пользователя
Посібник користувача
Användar Manual
Uživatelská příručka
Navodila za uporabo

Korisnički priručnik
Uputstvo za rukovanje
Používateľská príručka
Használati útmutató
Käyttöohje
Brukermanual
Manual del Usuario
Gebruiksaanwijzing
Brugervejledning
Manual de Utilizare
Instrukcja obsługi

Fig.1

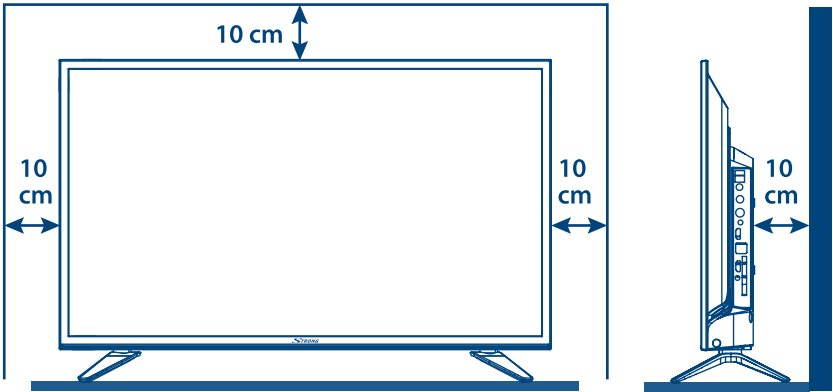

Fig.2

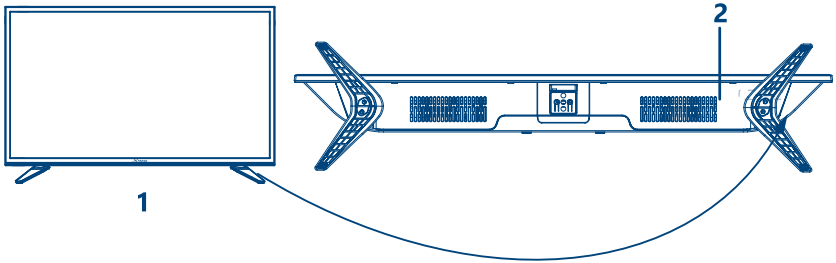

Fig.3a

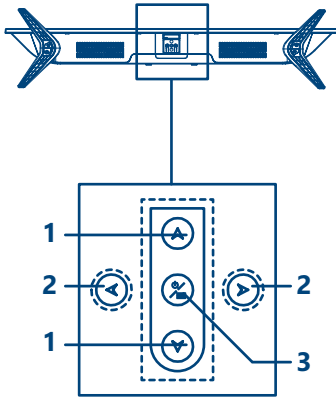

Fig.3b

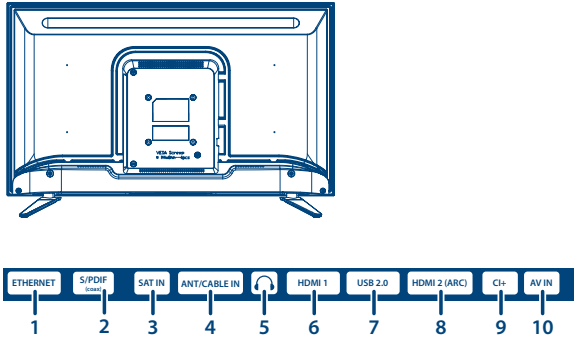

Fig.4

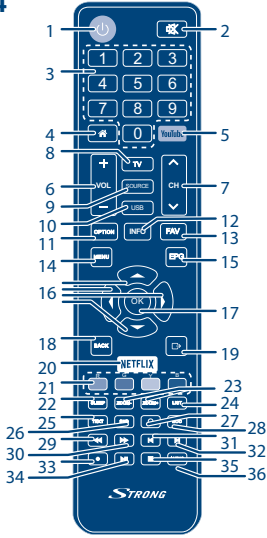

Fig.5

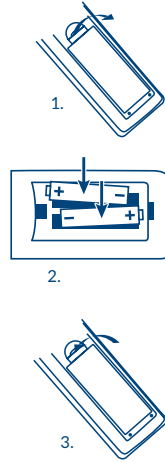

Fig. 6 a

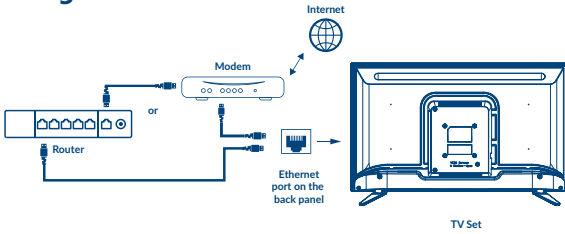

Fig. 6 b

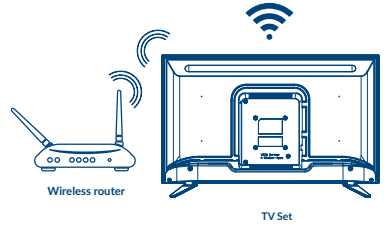

Fig. 7



Fig. 8



Fig. 9



SERVICE CENTER

AT	 support_at@strong.tv  0820 400 150 (€ 0,12/Min. österr. Festnetz)	HU	 support_hu@strong.tv  +36 1 445 26 10
BG	 support_bg@strong.tv  +359 32 634451	IT	 support_it@strong.tv  199 404 032 Da rete fissa 24,8 cent. al min. 12,5 cent. scatto alla risposta Da rete mobile max 49 cent. al min. 15,6 cent. scatto alla risposta
CZ	 support_cz@strong.tv  844 44 44 90	NL	 support_nl@strong.tv
DE	 support_de@strong.tv  0180 501 49 91 (€ 0,14/Min. deutsches Festnetz) (€ 0,42/Min. max. Mobilfunknetze)	PL	 support_pl@strong.tv  801 702 017
DK	 support_dk@strong.tv	PT	 support_pt@strong.tv  +351 2 100 06 125
ES	 support_es@strong.tv  +34 91 119 61 76	SK	 support_sk@strong.tv  0850 15 05 50
FR	 support_fr@strong.tv  0826 029 928 (€ 0,15 par mn poste fixe en France)	SL	 +386 1 828 08 58
HR	 +385 1 344 57 66	UA	 support_ua@strong.tv  +380 (44) 228 24 73

www.strong.tv

Supplied by STRONG Austria
Represented by STRONG Ges.m.b.H.
Franz-Josefs-Kai 1
1010 Vienna, Austria
Email: support_at@strong.tv

Licenses

THIS PRODUCT IS LICENSED UNDER THE AVC PATENT PORTFOLIO LICENSE FOR THE PERSONAL AND NONCOMMERCIAL USE OF A CONSUMER TO (i) ENCODE VIDEO IN COMPLIANCE WITH THE AVC STANDARD ("AVC VIDEO") AND/OR (ii) DECODE AVC VIDEO THAT WAS ENCODED BY A CONSUMER ENGAGED IN A PERSONAL AND NON-COMMERCIAL ACTIVITY AND/OR WAS OBTAINED FROM A VIDEO PROVIDER LICENSED TO PROVIDE AVC VIDEO. NO LICENSE IS GRANTED OR SHALL BE IMPLIED FOR ANY OTHER USE. ADDITIONAL INFORMATION MAY BE OBTAINED FROM MPEG LA, L.L.C. SEE [HTTP://WWW.MPEGLA.COM](http://www.mpegla.com)

This product contains one or more programs protected under international and U.S. copyright laws as unpublished works. They are confidential and proprietary to **Dolby Laboratories**. Their reproduction or disclosure, in whole or in part, or the production of derivative works therefrom without the express permission of Dolby Laboratories is prohibited. Copyright 2003-2009 by Dolby Laboratories. All rights reserved.

THIS PRODUCT IS SOLD WITH A LIMITED LICENSE AND IS AUTHORIZED TO BE USED ONLY IN CONNECTION WITH HEVC CONTENT THAT MEETS EACH OF THE THREE FOLLOWING QUALIFICATIONS: (1) HEVC CONTENT ONLY FOR PERSONAL USE; (2) HEVC CONTENT THAT IS NOT OFFERED FOR SALE; AND (3) HEVC CONTENT THAT IS CREATED BY THE OWNER OF THE PRODUCT. THIS PRODUCT MAY NOT BE USED IN CONNECTION WITH HEVC ENCODED CONTENT CREATED BY A THIRD PARTY, WHICH THE USER HAS ORDERED OR PURCHASED FROM A THIRD PARTY, UNLESS THE USER IS SEPARATELY GRANTED RIGHTS TO USE THE PRODUCT WITH SUCH CONTENT BY A LICENSED SELLER OF THE CONTENT. YOUR USE OF THIS PRODUCT IN CONNECTION WITH HEVC ENCODED CONTENT IS DEEMED ACCEPTANCE OF THE LIMITED AUTHORITY TO USE AS NOTED ABOVE.

SIMPLIFIED EU DECLARATION OF CONFORMITY

Hereby, **STRONG** declares that the radio equipment type LED TV is in compliance with Directive 2014/53/EU.

The full text of the EU declaration of conformity is available at the following internet address: <https://www.strong.tv/en/doc>

Subject to alterations. In consequence of continuous research and development technical specifications, design and appearance of products may change. Manufactured under license from Dolby Laboratories. Dolby Audio and the double-D symbol are registered trademarks of Dolby Laboratories. The terms HDMI and HDMI High-Definition Multimedia Interface, and the HDMI logo are trademarks or registered trademarks of HDMI Licensing Administrator, Inc in the United States and other countries. Wi-Fi is a registered trademark of Wi-Fi Alliance®. Netflix is a registered trademark of Netflix, Inc. YouTube™ is a trademark of Google Inc. All product names are trademarks or registered trademarks of their respective owners.

© STRONG 2019. All rights reserved.

To obtain the best performance and safety, please read this manual carefully. Please keep this manual for future reference.

TABLE OF CONTENTS

1.0 INSTRUCTION	3
1.1 Safety Instructions	3
1.2 Storage	4
1.3 Accessories	4
1.4 Equipment set-up	4
2.0 INSTALLATION	5
2.1 Default PIN code: 1234	5
2.2 Front panel	5
2.3 Rear panel	5
2.4 Remote control	6
2.5 Installing the batteries	7
2.6 Using the remote control	7
3.0 FIRST TIME INSTALLATION	7
4.0 ELECTRONIC PROGRAMME GUIDE (EPG)	8
5.0 NETWORK CONNECTION	8
5.1 Connecting to a wired network	8
5.2 Connecting to a wireless network	9
6.0 HOME MENU	9
7.0 MENU SETTINGS	9
7.1 Menu control	9
7.2 Picture menu	9
7.3 Sound menu	10
7.4 Channel menu	10
7.5 Smart TV menu	11
7.6 System menu	12
8.0 USB	12
8.1 Reminder when using the USB player	12
8.2 USB menu	13
9.0 TROUBLESHOOTING	15
10.0 SPECIFICATIONS	17

1.0 INSTRUCTION

1.1 Safety Instructions

Read all of the instructions before operating the set. Keep these instructions well for later use.

- Only use attachments/accessories specified or provided by the manufacturer (such as the exclusive supply adapter, battery etc.).
- Please refer to the information on the exterior back enclosure for electrical and safety information before installing or operating the apparatus.
- To reduce the risk of fire or electric shock, do not expose this apparatus to rain or moisture.
- The ventilation should not be impeded by covering the ventilation openings with items, such as newspaper, table-cloths, curtains, etc.
- The apparatus shall not be exposed to dripping or splashing and no objects filled with liquids, such as vases, shall be placed on the apparatus.
- The mark  indicates a risk of electric shock. The external wires must be installed by an instructed person or ready-made leads or cords must be used.
- To prevent injury, this apparatus must be securely attached to the floor/wall in accordance with the installation instructions.
- Danger of explosion if the battery is incorrectly replaced. Replace only with the same or equivalent types.
- The battery (battery or batteries or battery pack) shall not be exposed to excessive heat such as sunshine, fire or the like.
- Excessive sound pressure from earphones and headphones can cause hearing loss.
- Listening to music at high volume levels and for extended durations can damage one's hearing.
- In order to reduce the risk of damage to hearing, one should lower the volume to a safe, comfortable level, and reduce the amount of time listening at high levels.
- The mains plug or appliance coupler is used as disconnect device, it shall remain readily operable. When not in use and during movement, please take care of the power cord set, e.g. tie up the power cord set with cable tie or something like that. It shall be free from sharp edges or similar which can cause abrasion of the power cord set. When put into use again, please make sure the power cord is not damaged. In case of damages, please get the power cord replaced by a similar one with the same specifications. The absence of a light indication on the apparatus does not mean that it is fully disconnected from the mains. To disconnect the apparatus completely, the mains plug must be pulled out.
- Attention should be drawn to environmental aspects of battery disposal.
- No naked flame sources, such as lighted candles, should be placed on the apparatus.
-  To prevent the spread of fire, keep candles or other open flames away from this product at all times.
- A USB terminal can provide a maximum of 500 mA.
-  Equipment with this symbol is a Class II or double insulated electrical appliance. It has been designed in such a way that it does not require a safety connection to electrical earth.

Operating Environment

- Do not install this equipment in a confined space such as a bookcase or similar unit.
- Do not use the set near damp, and cold areas, protect the set from overheating.
- Keep away from direct sunlight.
- Do not use the set near dust place.
- Do not attach candle to accessible opening area, to avoid flammable foreign material from entering the TV.

WEEE Directive



Correct Disposal of this product. This marking indicates that this product should not be disposed with other household wastes throughout the EU. To prevent possible harm to the environment or human health from uncontrolled waste disposal, recycle it responsibly to promote the sustainable reuse of material resources. To return your used device, please use the return and collection systems or contact the retailer where the product was purchased. They can take this product for environment-safe recycling.

1.2 Storage

Your device has been carefully checked and packed before shipping. When unpacking it, make sure that all the parts are included and keep the packaging away from children. We recommend that you keep the carton during the warranty period, to keep your device perfectly protected in the event of repair or warranty.

1.3 Accessories

- 1x installation instructions
- 1x assembly instruction
- 1x Safety Instructions/Warranty Cards
- 1x remote control
- 2x AAA batteries

1.4 Equipment set-up

Fig. 1

Install the display on a solid horizontal surface such as a table or desk. For ventilation, leave a space of at least 10 cm free all around the set. To prevent any fault and unsafe situations, please do not place any objects on top of the set. This apparatus can be used in tropical and/or moderate climates.

This user manual provides complete instructions for installing and using this TV. The symbols serve as follows:

WARNING	Indicates warning information.
NOTE	Indicates any other additional important or helpful information.
MENU	Represents a button on the remote control or the TV. (Bold characters)
<i>Move to</i>	Represents a menu item within a window. <i>(Italic characters)</i>

2.0 INSTALLATION

2.1 Default PIN code: 1234

2.2 Front panel

Fig. 2

NOTE: The graphics are for representation only.

1. Power indicator /remote sensor
2. Speakers

2.3 Rear panel

Fig. 3a

NOTE:	The graphics are for representation only.
1. ▲▼	Scans up/down through the channel list. Within the menu system, the buttons operate with equal function of the ▲▼ buttons on the remote and adjust menu controls.
2. ◀▶	Increases/decreases the volume. Within the menu system, the buttons operate with equal function of the ◀▶ buttons on the remote and adjust menu controls.
3. ⏻/Menu	Turns the TV on or in standby. If the TV is on, press the button to display <i>Source Select</i> . In some menus, press to return to the previous menu. Long press for 3 seconds to display <i>NAV</i> menu.



















Fig. 3b

NOTE:	The graphics are for representation only.
1. ETHERNET	Connect to your Internet router to access the internet/apps.
2. S/PDIF (coax.)	Use an RCA cable to connect your TV to a compatible digital amplifier or Home theatre set.
3. SAT IN	Connect a coaxial cable to receive signal from the Dish LNB.
4. ANT/CABLE IN	Connect a coaxial cable to receive signal from the DVB-T/T2 antenna or cable.
5. 	Headphone or Earphone audio output, speakers will be muted when earphone is plugged in and headphone selected.
6. HDMI 1	Connect HDMI input signal from a signal source such as DVD, Blu-ray player or game console.
7. USB 2.0	USB 2.0 ports.
8. HDMI 2 (ARC)	Connect HDMI input signal from a signal source such as DVD, Blu-ray player or game console or directly to a Digital Amplifier that supports the ARC function. This input is equipped with the ARC (Audio Return Channel) feature to implement audio connections and for a full Dolby Audio support.
9. CI+	Insert a Conditional Access Module (CAM).
10. AV IN	To connect your video camera or other device using 3.5 mm AV cable to your TV to play videos on your TV screen.
NOTE:	If the TV turns off when you plug a cable to any connector, just turn it on again.

2.4 Remote control

Fig. 4

1. ⏻	Press to turn the TV on or standby.
------	-------------------------------------

- 2.  Press to mute or restore the volume.
- 3. 0~9 Choose channel directly.
- 4.  Enter the home desktop.
- 5. **YouTube** Press to enter YouTube immediately.
- 6. **VOL +/-** Adjust the volume up or down.
- 7. **CH +/-** Change programmes up or down.
- 8. **TV** Switch back to the TV mode.
- 9. **SOURCE** Select the input source mode.
- 10. **USB** Enter the multimedia menu.
- 11. **OPTION** Opens the smart menu.
- 12. **INFO** Display information about the current source.
- 13. **FAV** Press to view your assigned favourite channels. Press     to cycle through your favourite channels, press **OK** to confirm.
- 14. **MENU** Open the menu options.
- 15. **EPG** Press to display the current EPG information in DTV mode.
- 16.     Navigate the menu.
- 17. **OK** Confirm the selection.
- 18. **BACK** Press to go back to previously viewed channel. In menu: Back to previous menu.
- 19. **EXIT** Exit the current menu.
- 20. **NETFLIX** Press to enter Netflix immediately*
- 21. **COLOUR BUTTONS**
 - 22. **SLEEP** Press to execute the prompt function in TV or DTV mode. Select the sleep time, such as 10 min, 20 min etc.
 - 23. **ZOOM-/ZOOM+** Change aspect ratio.
 - 24. **LIST** Press to enter the channel list.
 - 25. **TEXT** Press to enter or exit the teletext menu.
 - 26. **SUB** Enable/disable subtitles in DTV mode.
 - 27.  Return to previous channel in TV mode.
 - 28. **ECO** Select desired power saving mode.
 - 29.  Press to fast reverse.
 - 30.  Press to fast forward.
 - 31.  Press to play the previous file.
 - 32.  Press to stop playback.
 - 33.  Press to pause playback, press again to continue playback.
 - 34.  Press to play the next file.
 - 35.  No function.
 - 36. **AUDIO** Select audio language.

* Membership is not included. Netflix is available in selected countries. Streaming Netflix requires to set up an account. Broadband Internet required. See www.netflix.com/TermsOfUse for details.

2.5 Installing the batteries

Fig. 5

Place 2x AAA batteries in the battery compartment of the remote control. Make sure to match the polarity markings inside the compartment.

NOTE:

Pictures are for reference only. Actual items may differ..

1. Open the cover.
2. Put 2x AAA batteries in the compartment and make sure the polarity is correct.

3. Close the cover.

Precautions for using the battery

Improper using of the battery will cause leakage. Carefully follow these instructions.

1. Please note the batteries' polarity to avoid short circuit.
2. When the battery's voltage is insufficient which affects the use range, you should replace it with a new battery. Remove the batteries from the remote-control unit if you do not intend to use it for a long time
3. Do not use different types of batteries (for example Manganese and Alkaline batteries) together.
4. Do not put the battery into fire, and charge or decompose the battery.
5. Please dispose batteries abide by relevant environmental protection regulation.

2.6 Using the remote control

- Use the remote control by pointing it towards the remote sensor. Items between the remote control and the remote sensor could block normal operation.
- Do not cause the remote control to vibrate violently. Also, do not splash liquid on the remote control, also do not put the remote control in a high humidity place.
- Do not place the remote control under direct sunlight which will cause deformation of the unit by heat.
- When the remote sensor is under direct sunlight or strong lighting, the remote control will not work. If so, please change the lighting or TV's position, or operate the remote control closer to the remote sensor.

3.0 FIRST TIME INSTALLATION

After all connections have been made properly, switch your TV on. The language selection will appear on the screen. Use ▲▼ to select the *Language* of your preference and select your country, confirm with **OK**. Then select your Country/Region and confirm your selection with **OK** or arrow right button. The *Terms and Conditions, Privacy Notice, Cookie Notice* will appear, please read it and confirm with **I agree**.

Now you can confirm your location. Here you can choose where you are using the TV. For normal use, you can use the *Home* setting. After you selected the setting which fits for your usage, confirm with **OK**.

The installation will proceed to the *Network SetUp* screen, choose between "Wireless", "Wired" or "I do not have a network connection" and confirm with **OK**. Follow the steps that follow to successfully complete your chosen option. If you choose "I do not have a network connection" you will be forwarded to the one screen further.

On the following screen, you can select the **TV channel Installation**. Choose the one option you like to use and follow the next instructions.

If you have chosen **Continue** option, you will be able to install channels. Select which installation you want to use: (Antenna, Cable or Satellite)

Digital to receive digital terrestrial broadcasts *Analogue* for analogue terrestrial reception or both to perform the installation of both choices simultaneously. Other tuners can be set-up if you choose for "I don't want to scan". If you have chosen this last option, you will now have the possibility to scan Cable tuner.

Select *Digital* or *Analogue* option to scan cable broadcasts or choose "I don't want to scan". If you have chosen this last option, you will now have the possibility to scan Satellite tuner.

Follow the steps that apply to your home installation to receive digital satellite broadcasts (if you have a satellite dish).

Follow the steps that appear on your TV screen to complete the installation of your TV and enjoy.

4.0 ELECTRONIC PROGRAMME GUIDE (EPG)

EPG stands for Digital Electronic Programme Guide. It is supplied by the programme providers and offers information on broadcasted programmes. You can access it in digital mode by pressing **EPG** on the remote control. Press **EPG** to bring up the EPG interface. Use ▲▼ to select a programme. Use ▲▼ and then ◀▶ to select channel you like to see EPG overview. Use ▲▼ to select a programme. Press ⏪ to stop and return to viewing modes.

Then press the **BUTTONS** for entering the required settings.

INFO	Access extra info of programme
YELLOW	Program Information 24+ hours.
GREEN	Program Information 24- hours.

5.0 NETWORK CONNECTION

Your TV can be connected to your home network in two ways:

- Wired, using the RJ-45 (LAN) connector on the back panel.
- Wireless, using the internal wireless and your home wireless network.

NOTE: To access the Internet, you must subscribe to a highspeed broadband Internet service with your Internet service provider.

NOTE: Instructions below are just the usual ways to connect your TV to a wired or wireless network. The connection method may differ depending on your actual network configuration. If you have any questions about your home network, please refer to your Internet service provider.

5.1 Connecting to a wired network

Fig. 6a

NOTE: The graphics are for representation only.

To connect to a wired network

1. Ensure you have:
 - An Ethernet cable long enough to reach your TV
 - A router or modem with an available Ethernet port
 - A highspeed Internet connection
2. Connect your Ethernet cable to the router and to the Ethernet port on the back of the TV.
3. Use the *Network Configuration* menu to configure the TV.

5.2 Connecting to a wireless network





Fig. 6b



NOTE: The graphics are for representation only.

To connect to a wireless network:

1. Ensure you have:
 - A router broadcasting a highspeed wireless signal
 - A highspeed Internet connection
2. Use the *Network Configuration* menu to configure the TV.

6.0 HOME MENU





The Home menu contains *Source*, *Smart* and *Apps*. To access the menu, press the  on the remote control. Use   to move and **OK** to enter the option. To exit the menu, press .

<i>Source</i>	Select the input sources of the devices which are connected to the TV through the different ports.
<i>Smart</i>	Displays the Smart TV settings. Press OK to enter, then   to select the option.
<i>Apps</i>	In this menu you find entertaining apps, like Netflix, YouTube, APP Store, Browser, Accu Weather etc.

7.0 MENU SETTINGS

Below items depend if they are available of select input source. Use **SOURCE** to select another source.

7.1 Menu control

Press **MENU** to enter the main menu. Press   to select Picture, Sound, Channel, Smart TV, Network, System or Support then press **OK** or . Press **OK** to enter the submenus. Press   to select options. Use **OK** to select an item, press **BACK** to exit the item. Some items are for information only and cannot be changed.

7.2 Picture menu

<i>Picture preset</i>	Adjust the picture setting that best suits your viewing environment.
<i>Backlight</i>	Adjust the backlight levels of the picture.
<i>Brightness</i>	Adjust the brightness of the picture.
<i>Contrast</i>	Adjust the difference between the light and dark areas of the picture.
<i>Saturation</i>	Adjust the richness of colour.
<i>Tint</i>	Adjust the balance between the red and green levels.
<i>Sharpness</i>	Adjust the crispness of the edges in the picture.
<i>Colour Temperature</i>	Adjust the colour temperature of the picture.
<i>Overscan</i>	Select ON or OFF to turn on/off this option.
<i>Micro Dimming</i>	Select ON or OFF to turn on/off micro dimming.

<i>Advanced Settings</i>	Select more picture advanced settings.
<i>Picture reset</i>	Restores the current picture settings to default.

7.3 Sound menu

<i>Sound preset</i>	Select a preset audio option, optimized for different sounding conditions.
---------------------	--

NOTE: When Sound preset is set to different mode, five Sound options (100 Hz, 500 Hz, 1.5 KHz, 5 KHz and 10 KHz) will be adjusted, which enable to adjust the frequency levels desired. You can also set the options to your desired levels.

<i>Balance</i>	Control the sound balance between the right and left loudspeaker (earphone).
<i>Auto Volume control</i>	Adjust the volume corresponding to the input audio level. Options are ON and OFF.
<i>S/PDIF type</i>	When connected to a digital amplifier you can select <i>PCM</i> to have all audio converted to a 2-channel stereo. Select <i>Auto</i> to keep the audio settings as they are or OFF to turn off.
<i>S/PDIF Delay</i>	Here it is possible to set up S/PDIF Delay and Speaker Delay.
<i>Audio delay</i>	Here you can choose between <i>Normal</i> and <i>Visual Impaired</i> .
<i>TV placement</i>	Select Desktop or Wall mound mode.
<i>Advanced Settings</i>	Select more sound advance settings.

7.4 Channel menu

Press **MENU** to display the main menu. Press **▲**Down} to select *Channel* in the main menu. Press **▲**▼ to choose the menu and press **OK** to enter the sub-menu.

NOTE: This function is only available in TV mode.

<i>Channel scan</i>	Scan for all available analogue and digital channels.
<i>Channel List</i>	Show all searched channels in a list.
<i>EPG</i>	Press OK ▶ to enter the Programme Guide menu.
<i>Channel organiser</i>	Skip, sort, edit and delete channels (see chapter 7.4.1 for more details)
<i>Channel diagnostics</i> (on digital TV channels)	Press OK ▶ to display some signal information on current digital channel, such as signal strength, Frequency etc.
<i>Subtitle</i>	Choose between <i>ON</i> and <i>OFF</i> .
<i>Primary Subtitle language</i>	Set a primary Subtitle language.
<i>Secondary Subtitle language</i>	Set a secondary Subtitle language.
<i>Subtitle type</i>	Press OK ▶ to enter, press ▲ ▼ to select a subtitle type. Select Hearing impaired to display the hearing-impaired subtitles with your selected language.

Teletext

Use ▲▼ to select the teletext language.

7.4.1 Channel organiser

Select "Setting" -> "Channel" -> "Channel organiser". You find 4 submenus: Channel skip, Channel sort, Channel edit, Channel delete

7.4.1.1 Channel skip

Enter Channel skip. If you want to hide the channel from the channel list, just select it.

7.4.1.2 Channel sort

Enter Channel sort. There are two types: Channel swap and Channel insert

Channel swap: to exchange the channel order of two channels of the same type, first need to select the two channels to be exchanged, press **OK** to exchange the order of two channels. When the number of channels exceeds one page, the Quick jump function will take effect, which is used to quickly jump to the channel number entered by the user.

Channel insert, which is used to adjust the order of selected channels. After selecting the channel to be inserted, move the cursor to the place to be inserted and press the **RED** button to insert.

7.4.1.3 Channel edit

Channel editing function, select the specified channel, press **OK** to edit channel number or channel name.

7.4.1.4 Channel delete

This function is used to delete the selected channels. If there are too many channels, it will take a little more time. Please be patient.

7.5 Smart TV menu

Press **MENU** to display the main menu. Press ▲▼ to select *Smart TV* in the main menu. Press **OK** to enter the sub-menu.

Smart TV portal

Enjoy Internet Applications (Apps), specially adapted Internet websites for your TV. Control the Apps with the TV remote control.

Share & See

Enjoy recorded video, picture and music saved on your PC.

Wireless Display

Share screen and sound of your device such as smartphone or tablet to your TV wirelessly.

Smart TV policy

Press **OK** or ► to read the Smart TV policy.

Networked standby

Press **OK** or ► to select OFF or ON.

Netflix Setting

Here you can deactivate your device from Netflix.

HbbTV Setting

Enhanced and interactive television services provide signalling, transmission and presentation mechanisms.

Reset smart TV

Reset the settings of smart TV.

Use "Wireless Display" to mirror the screen of your smartphone or mobile device to your TV.

NOTE: “Wireless Display” app requires a compatible app on your smartphone or mobile device. Please download an app for media sharing and wireless display from the App Store or Google Play Store to use these features on your TV.

WARNING:

- Configure the network settings before using Smart TV.
- Slow responses and/or interruptions may occur, depending on your network conditions.
- If you experience a problem using an application, please contact the content provider.
- According to circumstances of the content provider, an application’s updates or the application itself may be discontinued.
- Depending on your country’s regulations, some applications may have limited service or not be supported.

7.6 System menu

Press **MENU** to display the main menu. Press **▲/▼** to select *System* in the main menu, then press **OK** to enter the sub-menu.

<i>Menu language</i>	Press OK/▶ to display the language list and use ▲/▼ to select a language.
<i>Timer</i>	Select local time zone.
<i>Clock</i>	Select to turn on Auto synchronisation. Select OFF to set options manually.
<i>Sleep timer</i>	Set a period of time after which the TV set goes in standby mode.
<i>Auto standby</i>	Set a period of time after which the TV set goes in standby mode.
<i>Lock</i>	Control the special function for TV. Factory default code is 1234. Super password is 0423.
<i>Input Settings</i>	Select the device name of the input source.
<i>Location</i>	Select Home or Shop mode depending on your viewing environment.
<i>Common Interface</i>	Press OK or ▶ to enter the Common Interface.
<i>T-Link</i>	Use this function to turn on the ARC function and search for CEC devices connected to the HDMI connector of your TV.
<i>Auto source</i>	Press OK or ▶ to select ON or OFF .
<i>Sports Mode</i>	Press OK or ▶ to select ON or OFF .
<i>LED indicator</i>	Press OK or ▶ to select Flashing , Normal or OFF .
<i>Instant power on</i>	Press OK or ▶ to select ON or OFF .
<i>Restore Factory Default</i>	Press OK or ▶ to enter password.
<i>Software Update</i>	You can update the TV’s software via USB, by network or by channel.

8.0 USB

8.1 Reminder when using the USB player

1. Some USB storage devices may not be compatible to operate smoothly with this TV.

2. Back up all of the data in the USB storage device in case data is lost due to an unexpected accident. STRONG does not assume any liability for the losses by misuse or malfunction. Data backup is consumer's responsibility.
3. For large file sizes, the loading speed may be slightly longer.
4. The recognition speed of a USB storage device may depend on each device.
5. When connecting or disconnecting the USB storage device, make sure the TV is not in USB mode, otherwise the USB storage device or the files stored in it may be damaged.
6. Please use only a USB storage device which is formatted in FAT16, FAT32, NTFS (playback only) file system provided with the Windows operating system. In case of a storage device formatted as a different utility programme which is not supported by Windows, it may not be recognized.
7. When using a USB Hard Disk Drive, which is not powered independently, ensure its power does not exceed 500 mA. Otherwise the TV system will change into standby mode, and you must pull out the USB Hard Disk and restart the TV system.
8. An "Unsupported File" message will be displayed if the file format is unsupported or the file is corrupted.
9. FHD big picture needs longer time to process, which is not caused by the TV. Please be patient.
10. This TV may not support some multimedia files changed and upgraded as the change of the encoding format or other technical aspects advances.

8.2 USB menu

You can view movies, music, photo or browser files from your USB storage devices. Connect a USB storage device to the USB input terminal and select the types of media on the Multimedia page: *Movie*, *Music*, *Photo* and *text*. Press **OK** or **▶**, the screen will show the connected USB device, press **OK** again to view the file folders and files. Press **▲▼** or **◀▶** to select a folder, press **OK** to open the folder and select the files. Highlight the one you want to play or watch or press directly **▶||** to start playing directly. Press **■** to stop playing and return to upper level folder. Continuously press **RETURN** to go back to upper level folder. Repeat again to select and play another media type.

NOTE: By choosing one of the three media types, for example *Movie*, the folders inside will display only video files and no other formats.

8.2.1 Play movies

Fig. 7

During playback, press **INFO** to display/exit the menu bar (Fig. 7). Press the **USB control buttons** on the remote control to do relevant operations.

- | | |
|----------------------------------|---|
| <i>Pause/Stop/Prev./Next</i> | Press ▶ to play or pause the playback. Press ■ to stop playing. Press ◀▶ to play the previous or the next video file. Press INFO and use ◀▶ to highlight the corresponding icon on the control bar, then press OK . The TV will response accordingly. |
| <i>Fast Reverse/Fast Forward</i> | Press and hold ◀▶ for seconds to draw the playing progress as your desire, then press ▶ to start the playing from the new position. |
| <i>Mode</i> | Highlight the corresponding icon and press OK to switch to another play mode. |
| <i>Sound</i> | Highlight the corresponding icon and press OK to select the sound mode. |
| <i>Info</i> | Highlight the corresponding icon and press OK to view the information of the playing video. |

Picture

Highlight the button and press **OK** to select the display mode.

8.2.2 Play music

Fig. 8

Press **INFO** or **OK** to display/exit from the menu bar. Press the **USB control buttons** on the remote control to do relevant operations.

Pause/Stop/Previous/Next Press **▶ ||** to play or pause the playback. Press **■** to stop playing. Press **◀▶** to play the previous or the next music file. Press **◀▶** to highlight the corresponding icon on the control bar, and then press **OK**. The TV will response accordingly.

Fast Forward/Fast Reverse Press and hold **◀▶** for seconds to draw the playing progress as you wish, then press **▶ ||** on the remote control to start playing from the new position.

Info Highlight the icon and press **OK** to check the information of the playing music.

NOTE:

- If one (or more) file(s) of the play list is selected, the buttons **◀▶** will play only selected files.
- This menu only shows supported files.
- Files with other file extensions are not displayed, even if they are saved on the same USB storage device.
- An over-modulated mp3 file may cause some sound distortion during playback.
- This TV supports lyrics display (in English). The maximum number of characters per line is 48.
- The file name of music and lyrics must be the same in order to display lyrics while the music is playing.
- If you want to show the associated lyrics on the screen with the music, you must store these in the same folder using the same file name with ".lrc" file extensions.

8.2.3 Browse photos

Fig. 9

Press during viewing **INFO** or **OK** to display/exit from the menu bar. Press the **USB control buttons** on the remote control to do relevant operations.

Pause/Stop/FB/FF Press **▶ ||** to play or pause the playback. Press **■** to stop playing. Press **◀▶** to show the previous or the next picture. Press **◀▶** to highlight the icon on the control bar, and then press **OK**. The TV will response accordingly.

Rotate Highlight the icon in the menu bar and press **OK** to rotate the picture 90 degrees clockwise or counter clockwise.

Zoom In/Zoom Out Highlight the icon on the menu bar and press **OK** to zoom in or zoom out of the image.

BGM Background music: If you additionally saved music files on the very USB flash drive, you can playback music files while viewing your photos.

NOTE:

The move function  is only available when the image is enlarged.

8.2.4 Browse text documents

Press ◀▶ to select *Text* in the main menu. Then press ◀▶ to select the drive disk you choose to watch and **OK** to enter. Select the file you want to display by using ▲▼◀▶ and confirm with **OK**. Quit step by pressing **OK**. Press ◀▶ to select *return* and go back to previous menu.

8.2.5 Software update via USB

From time to time you can check if there is an improved software version available. This can be viewed and downloaded from our website www.strong.tv. Search the model number on our website's service support section. If there is an improved software version you can download the file and copy it to the root of a USB device. Then press ▲▼ button to select *Software Update (USB)* from the *SETUP* menu on your TV. Afterwards plug your USB device into the USB slot and press **OK** to update the respective software. Confirm with *Yes* using ◀▶. When the update is completed, remove the USB stick, disconnect your device from the main power supply and plug in again.

9.0 TROUBLESHOOTING

Before calling a service technician, review following information for possible causes and solutions for the problem you are experiencing. If the TV does not work properly after checking it, please contact your local service line or STRONG dealer. Alternatively, you can send a support mail via our website www.strong.tv.

Problem	Possible cause and solution
No picture, no sound	<ol style="list-style-type: none"> 1. Check if the fuse or circuit breaker is working. 2. Plug another electrical device into the outlet to make sure it is working or turned on. 3. The power plug is in bad contact with the outlet 4. Check the signal source.
No colour	<ol style="list-style-type: none"> 1. Change the colour system. 2. Adjust the saturation. 3. Try another channel. Black-white programme may be received.
The remote control does not work	<ol style="list-style-type: none"> 1. Change the batteries. 2. The batteries are not installed correctly. 3. Main power is not connected.
No picture, normal sound	<ol style="list-style-type: none"> 1. Adjust the brightness and contrast. 2. Broadcasting failure may happen.
Normal picture, no sound	<ol style="list-style-type: none"> 1. Press the volume up button to increase the volume. 2. The volume is set to mute, press  to restore the sound. 3. Change the sound system. 4. Broadcasting failure may happen.
Unorderly ripples on the picture	It is usually caused by local interference, such as cars, daylight lamps and hair driers. Adjust the antenna to minimize the interference.

Problem	Possible cause and solution
Snowy dots, blocking and interference	<p>If the antenna is located in the fringe area of a television signal where the signal is weak, the picture may be marred by dots, show blocking or break-ups. When the signal is extremely weak, it may be necessary to install a special antenna to improve the reception.</p> <ol style="list-style-type: none"> 1. Adjust the position and orientation of the indoor/ outdoor antenna. 2. Check the connection of the antenna. 3. Fine tune the channel. 4. Try another channel. Broadcasting failure may happen.
Ghost	<p>Ghosts are caused by the television signal following two paths. One is the direct path, the other is reflected from tall buildings, hills, or other objects. Changing the direction or position of the antenna may improve the reception.</p>
Radio frequency interference	<p>This interference produces moving ripples or diagonal streaks, and in some case, loss of contrast in the picture. Find out and remove the radio interference source.</p>
Playback of video is causing picture freeze/macro blocks or similar distortion, especially on HD content	<p>Read/write speed of your USB device could be too low. Make sure to use a USB storage device with sufficient speed and space. Pen drives (USB sticks) may not support sufficient speed.</p>
No signal or weak signal, intermittent reception	<ol style="list-style-type: none"> a. Cables might have loosened; moisture might have entered into cables or connectors, heavy rain at present or heavy storm at present. Check the cable connections, LNB and other equipment connected between the LNB and the receiver, or peak the dish. Wait for rain/storm to subside. Ask a local satellite specialist for advice. The satellite dish is not pointing at the (correct) satellite(s). Adjust the dish. Ask a local satellite specialist for advice. b. Satellite dish is too small, trees or buildings in path. c. Change to a larger dish or change position of dish. d. Signal is too strong, dish is oversized. e. Connect a signal attenuator to the LNB input. Ask a local satellite specialist for advice.
Bad picture/blocking error during heavy rain.	<p>Heavy rain will attenuate satellite signals, below a certain level blocking will occur.</p> <p>Make sure your dish installation is up to standards to minimize rain effects. When in doubt, ask a local satellite specialist for advice.</p>
If the TV turns off after plugging a cable into any connector	<p>Again, turn on the TV.</p>

NOTE:

If the problem persists after these solutions, please contact your local support centre or send a support mail via our website www.strong.tv

10.0 SPECIFICATIONS

Audio

Audio Output:	32": 5 W + 5 W 40": 8 W + 8 W
---------------	----------------------------------

Video

Channel coverage:	DVB-T2: 174 MHz-230 MHz; 470 MHz-860 MHz DVB-C: 113-858 MHz DVB-S2: 950 MHz-2150 MHz
System:	DTV: DVB-T2, DVB-S2, DVB-C ATV: PAL/SECAM (BG/DK/1) AV: PAL, NTSC

Connectors 32 & 40 inch

1 x ANT/CABLE IN
1 x SAT IN
1 x CI+
2 x HDMI
2 x USB
1x LAN (RJ-45)
1 x S/PDIF (coax.)
1x AV IN 3,5 mm
1x HEADPHONES

General Data

Operating voltage:	180 ~ 240 V AC 50/60 Hz
Power consumption:	32": max. 50 W, typ. 31 W 40": max. 75 W, typ. 60 W
Power consumption in standby:	32", 40": ≤ 0.5 W
Operating temperature:	+5 °C ~ +35 °C
Storage temperature:	-15 °C ~ +45 °C
Operating humidity:	20% ~ 80% RH, non-condensing
Storage humidity:	10% ~ 90% RH, non-condensing
Dimensions (WxHxD) in mm:	32": 732 x 479 x 174 40": 905 x 570 x 211
Net-weight:	32": 4,2 kg 40": 6,2 kg

Data Protection:

Please be aware that STRONG, its manufacturing partners, the application providers and the providers of the services may collect and use technical data and related information, including but not limited to technical information about this device, system and application software and peripherals. STRONG, its manufacturing partners, the application providers and the providers of the services may use such information to improve its products or to provide services or technologies to you, as long as it is in a form that does not personally identify you.

Additionally, please keep in mind that some services provided - already in the device or installed by you - may request a registration for which you have to provide personal data.

Beside that, please be aware that some services which are not pre-installed but can be installed may collect personal data even without providing additional warnings and that STRONG cannot be held liable for a possible breach of data protection by services not pre-installed.